



On-Board[®] FastRegen[™]
Control Module (with 24 VDC Supply)
Programming and Operation
Instructions

Information provided within this document is subject to change without notice, and although believed to be accurate, Brooks Automation assumes no responsibility for any errors, omissions, or inaccuracies.

AcuLigner™, Align™, AquaTran™, AutoTeach™, ATR™, AXM™, Basic Blue™, BiSymmetrik™, CenterSmart™, Cool Solutions™, Crate to Operate™, e-RMA™, e-Spares™, e-Volution™, FastRegen™, FIXLOAD™, FrogLeg™, InLigner™, InCooler™, Interface™, Jet Engine™, LowProfile™, M2 Nano™, Mini-Ion™, PASIV™, PowerPak™, PerformanceBlue™, PowerPak™, PowerTools™, QuadraFly™, Radius™, Radiant™, Radiant Express™, Reliance™, Reliance ATR™, RetroEase™, SCARA™, SmartPM™, SPOTLevel™, Synetics™, The New Pathway to Productivity™, Time Optimized Trajectory™, Time Optimal Trajectory™, Time Optimized Path™, TopCooler™, TopLigner™, Ultimate Blue™, VAC-407™, VacuTran™, Vacuum Quality Monitor™, VQM™, Vacuum Quality Index™, VQI™, and the Brooks logo are trademarks of Brooks Automation, Inc.

AcuTran®, AquaTrap®, Conductron®, Convector®, the Cool Solutions logo, Cryodyne®, Cryotiger®, Cryo-Torr®, Fusion®, GOLDLink®, Granville-Phillips®, Guardian®, GUTS®, Helix®, Jet®, Leapfrog®, MagnaTran®, MapTrak®, Marathon®, Marathon 2®, Marathon Express®, Micro-Ion®, MiniConvector®, On-Board®, Polycold®, Razor®, Simplicity Solutions®, the Simplicity Solutions logo, Stabil-Ion®, TrueBlue®, TurboPlus®, Vision®, Zaris®, and the Brooks Automation logo are registered U.S. trademarks of Brooks Automation, Inc.

All other trademarks are properties of their respective owners.

© 2013 Brooks Automation, Inc. All Rights Reserved. The information included in this manual is Proprietary Information of Brooks Automation and is provided for the use of Brooks Automation customers only and cannot be used for distribution, reproduction, or sale without the express written permission of Brooks Automation. This information may be incorporated into the user documentation, however any changes made by the user to this information is the responsibility of the user.



For Technical Support:

Location	GUTS® Contact Number
North America	+1-800-FOR-GUTS (1-800-367-4887) +1-978-262-2900
Europe	+49-1804-CALL-GUTS (+49-1804-2255-4887)
Japan	+81-45-477-5980
China	+86-21-5131-7066
Taiwan	+886-3-5525225
Korea	+82-31-288-2500
Singapore	+65-6464-1481

Visit us online: www.brooks.com

January 15, 2013 Part Num 8040603 Revision AA

This technology is subject to United States export Administration Regulations and authorized to the destination only; diversion contrary to U.S. law is prohibited.

Printed in the U.S.A.

Table of Contents

Section 1 - Basic On-Board Module Information

Introduction	1-1
Microprocessor Control System	1-1
Remote Operation Options	1-1
Keypad/Display Control Description	1-2
Alphanumeric Display	1-2
Horizontal Scroll Display Keys	1-2
Vertical Scroll Display Keys (Last, Next)	1-3
Clear Display Key	1-3
Numeric Keypad	1-3
Enter Command Key	1-3
Function Keys	1-3
On-line Help	1-3
Software Version Identification	1-4

Section 2 - System Power

Before You Start	2-1
Starting the Cryopump	2-1
Shutting Down the Cryopump	2-1

Section 3 - Programming and Operation

Introduction	3-1
Normal Operation	3-1
MONITOR Function	3-1
Cryopump ON/OFF and Second Stage Temperature	3-3
First and Second Stage Temperature and Auxiliary Thermocouple Pressure ..	3-3
First Stage Temperature in Kelvin	3-4
Second Stage Temperature in Kelvin	3-4
Auxiliary Thermocouple Gauge Pressure	3-5
Cryo Thermocouple Gauge Pressure	3-5
Relay 1 ON/OFF and Auto/Manual Control	3-6
Relay 2 ON/OFF and Auto/Manual Control 6	3-6
MONITOR Function Operation	3-7
Regeneration Function	3-8
REGEN ON/OFF	3-13
Delay Start	3-13
Delay Restart	3-14
Fast Rough Test	3-14
Extended Purge	3-15

Table of Contents (continued)

Repurge	3-15
Repurge Cycles	3-16
Base Pressure	3-16
Rate-of-Rise	3-17
ROR Cycles	3-17
Rough Valve Interlock	3-18
Power Fail Recovery	3-18
Power Fail Recovery Temperature	3-19
REGEN Function Programming	3-20
Initiate REGEN	3-20
Abort REGEN	3-20
Delay Start	3-20
Delay Restart	3-21
Fast Rough Test	3-21
Extended Purge	3-22
Repurge	3-22
Repurge Cycles	3-22
Base Pressure	3-23
Rate-of-Rise (ROR)	3-23
Rate-of-Rise (ROR) Cycles	3-24
Rough Valve Interlock	3-24
Power Failure Recovery	3-25
Power Failure Recovery Temperature	3-25
Performing a Fast or Full Regeneration Cycle	3-26
Fast Regeneration Cycle	3-26
Full Regeneration Cycle	3-26
REGEN Cycle Examples	3-27
SERVICE Function	3-32
Serial Number and Software Version	3-34
Network Identification Number	3-35
Elapsed Pump Time	3-35
Time Since Last Full Regeneration	3-36
Time Since Last Fast Regeneration	3-36
Password	3-37
Lock Mode	3-37
Parameter Lock	3-38
Zero Auxiliary Thermocouple	3-38
Zero Cryo Thermocouple	3-39
First Stage Temperature Control	3-39
SERVICE Function Operation	3-40
Serial Number and Software Version	3-40

Table of Contents (continued)

Net Identification	3-40
Elapsed Pump Time	3-40
Time Since Last Full Regeneration	3-40
Time Since Last Fast Regeneration	3-41
Password	3-41
Lock Mode	3-41
Parameter Lock	3-42
Zero Auxiliary Thermocouple	3-42
Zero Cryo Thermocouple	3-43
First Stage Temperature Control	3-43
CONTROL Function	3-44
Cryopump ON/OFF and Second Stage Temperature	3-46
Aux TC ON/OFF and TC Pressure	3-47
Cryo TC ON/OFF and TC Pressure	3-47
Rough Valve Open/Closed	3-48
Purge Valve Open/Closed	3-49
Relay 1 ON/OFF and Auto/Manual Control	3-50
Relay 2 ON/OFF and Auto/Manual Control	3-50
CONTROL Function Operation	3-51
Cryopump ON/OFF and Second Stage Temperature	3-51
Aux TC ON/OFF and TC Pressure	3-51
Cryo TC ON/OFF and TC Pressure	3-51
Rough Valve Open/Closed	3-52
Purge Valve Open/Closed	3-52
Relay 1 ON/OFF and Auto/Manual Control	3-52
Relay 2 ON/OFF and Auto/Manual Control	3-53
RELAYS Function	3-54
Select Relay 1 or 2	3-56
Current State of Relay ON/OFF, Auto/Manual	3-57
Current Program for Automatic Control	3-57
First Stage Temperature Limits	3-58
Second Stage Temperature Limits	3-58
Cryo Thermocouple Pressure Limits	3-59
Auxiliary Thermocouple Pressure Limits	3-59
Cryopump	3-60
Regeneration	3-60
Roughing Valve	3-61
Delay Activation of Relay	3-61
RELAYS Function Operation	3-62
Programming First Stage Temperature Limits	3-62
Programming Second Stage Temperature Limits	3-63

Table of Contents (continued)

Programming Cryo Thermocouple Pressure Limits	3-63
Programming Auxiliary Thermocouple Pressure Limits	3-64
Cryopump	3-64
REGEN Track	3-65
Rough Valve	3-65
Time Delay	3-66
FastRegen Control Module Software Function Parameters	3-66

Section 4 - On-Board Module Replacement

Module Ordering Information	4-1
Module Replacement	4-1

Appendix A - Customer Support Information

Appendix B - On-Board Module RS-232 Interface Protocol Format

Appendix C - RS-232 Regeneration Responses

Appendix D - RS-232 Power Failure Recovery Messages

Appendix E - On-Board Keypad/Display Error Messages

Appendix F - User I/O

Figures

Figure 1-1: On-Board Keypad/Display	1-2
Figure 1-2: On-line Help Message Example	1-4
Figure 3-1: MONITOR Function Flowchart	3-2
Figure 3-2: ON/OFF Status and Second Stage Temperature	3-3
Figure 3-3: First and Second Stage Temp. and Aux. Thermocouple Pressure	3-3
Figure 3-4: First Stage Temperature	3-4
Figure 3-5: Second Stage Temperature	3-4
Figure 3-6: Auxiliary Thermocouple Gauge Pressure	3-5
Figure 3-7: Cryo Thermocouple Gauge Pressure	3-5
Figure 3-8: Relay 1 Automatic or Manual Control	3-6
Figure 3-9: Relay 2 Automatic or Manual Control	3-6

Table of Contents (continued)

Figure 3-10: Fast Regeneration Cycle Function Flowchart	3-10
Figure 3-11: Full Regeneration Cycle Function Flowchart	3-11
Figure 3-12: REGEN ON/OFF Display	3-13
Figure 3-13: Delay Start of Regeneration Display	3-13
Figure 3-14: Delay Restart Display	3-14
Figure 3-15: Fast Rough Test Display	3-14
Figure 3-16: Extended Purge Display	3-15
Figure 3-17: Repurge Display	3-15
Figure 3-18: Repurge Cycles Display	3-16
Figure 3-19: Base Pressure Display	3-16
Figure 3-20: Rate-of-Rise Display	3-17
Figure 3-21: ROR Cycles Display	3-17
Figure 3-22: Rough Valve Interlock Display	3-18
Figure 3-23: Power Fail Recovery Display	3-19
Figure 3-24: Power Fail Recovery Temperature Display	3-19
Figure 3-25: On-Board Cryopump Full Regeneration Cycle Example	3-27
Figure 3-26: On-Board Cryopump Fast Regeneration Cycle Example	3-30
Figure 3-27: SERVICE Function Flowchart	3-33
Figure 3-28: Serial Number and Software Version Display	3-34
Figure 3-29: Network Identification Number Screen	3-35
Figure 3-30: Elapsed Pump Time Display	3-35
Figure 3-31: Time Since Last Full Regeneration Display	3-36
Figure 3-32: Time Since Last Fast Regeneration Display	3-36
Figure 3-33: Password Screen Display	3-37
Figure 3-34: Lock Mode OFF Display	3-37
Figure 3-35: Parameter Lock ON Display	3-38
Figure 3-36: Zero Auxiliary Thermocouple Display	3-38
Figure 3-37: Zero Cryo Thermocouple Gauge Display	3-39
Figure 3-38: First Stage Temperature Control Display	3-39
Figure 3-39: CONTROL Function Flowchart	3-45
Figure 3-40: Cryopump ON/OFF and Second Stage Temperature Display ..	3-46
Figure 3-41: Aux TC ON/OFF and TC Pressure Display	3-47
Figure 3-42: Cryo TC ON/OFF and TC Pressure Display	3-47
Figure 3-43: Rough Valve Open/Closed Display	3-48
Figure 3-44: Purge Valve Open/Closed Display	3-49
Figure 3-45: Relay 1 ON/OFF and Auto/Manual Control Display	3-50
Figure 3-46: Relay 2 ON/OFF and Auto/Manual Control Display	3-50
Figure 3-47: RELAYS Function Flowchart	3-55
Figure 3-48: Select Relay 1 or 2 Display	3-56
Figure 3-49: Current State of Relay ON/OFF, Auto/Manual	3-57
Figure 3-50: Current Program for Automatic Control Display	3-57

Table of Contents (continued)

Figure 3-51: First Stage Temperature Limits Display	3-58
Figure 3-52: Second Stage Temperature Limits Display	3-58
Figure 3-53: Cryo Thermocouple Pressure Limits Display	3-59
Figure 3-54: Auxiliary Thermocouple Pressure Limits Display	3-59
Figure 3-55: Cryopump Display	3-60
Figure 3-56: Regeneration Display	3-60
Figure 3-57: Roughing Valve Display	3-61
Figure 3-58: Delay Activation of Relay Display	3-61
Figure 4-1: On-Board FastRegen Control Module Component Location	4-2
Figure F-1: User Input/Output Connector Pin Assignments	F-2

Tables

Table 3-1: REGEN Function Parameters	3-12
Table 3-2: SERVICE Function Parameters	3-34
Table 3-3: CONTROL Function Parameters	3-46
Table 3-4: RELAYS Function Parameters	3-56
Table 3-5: On-Board FastRegen Control Module Software Parameters	3-67
Table B-1: On-Board Module RS-232 Commands	B-6
Table C-1: RS-232 REGEN Responses and Descriptions	C-2
Table D-1: Power Failure Recovery Messages	D-1
Table E-1: Keypad/Display Error Messages	E-1
Table F-1: User I/O Connector Pin Assignments	F-2

Section 1 - Basic On-Board Module Information

Introduction

Section 1 describes the following information which is common to all On-Board Modules: microprocessor control, remote operations, keypad/display, on-line help, software version and verification.

Microprocessor Control System

The On-Board Cryopump is equipped with a state-of-the-art microprocessor controlled Module which allows you to monitor, program and operate a wide range of important vacuum system functions.

The On-Board Module communicates with the Cryopump through a keypad/display that is mounted on the Cryopump. You can operate the keypad/display by merely pushing an easily learned sequence of keys.

Refer to **Section 3 - Programming and Operation** for a complete description of programming and operation information of each On-Board Module function.

Remote Operation Options

A remote keypad/display, which mounts in a standard 19 inch electronics rack, is available as an option. The remote keypad/display provides the same functionality of the Cryopump mounted device but can be located in a different location from the Cryopump. Refer to Section 1 of the appropriate **On-Board Cryopump Installation and Service Instructions** manual for more information.

The On-Board Module is also capable of being controlled from a personal or host computer via the RS-232 port on the rear of the module. The RS-232 port is standard equipment. Refer to **Appendix B** for more information. All On-Board modules, except for the R Module, can be controlled via the On-Board Network Terminal using the network connectors located on the rear of the module.

Keypad/Display Control Description

The On-Board keypad/display, shown in Figure 1-1, provides a user interface to the On-Board System for programming and operating all On-Board Cryopump functions. Figure 1-1 shows the location of all function keys and the alphanumeric display. The paragraphs that follow explain the purpose of each keypad/display function.

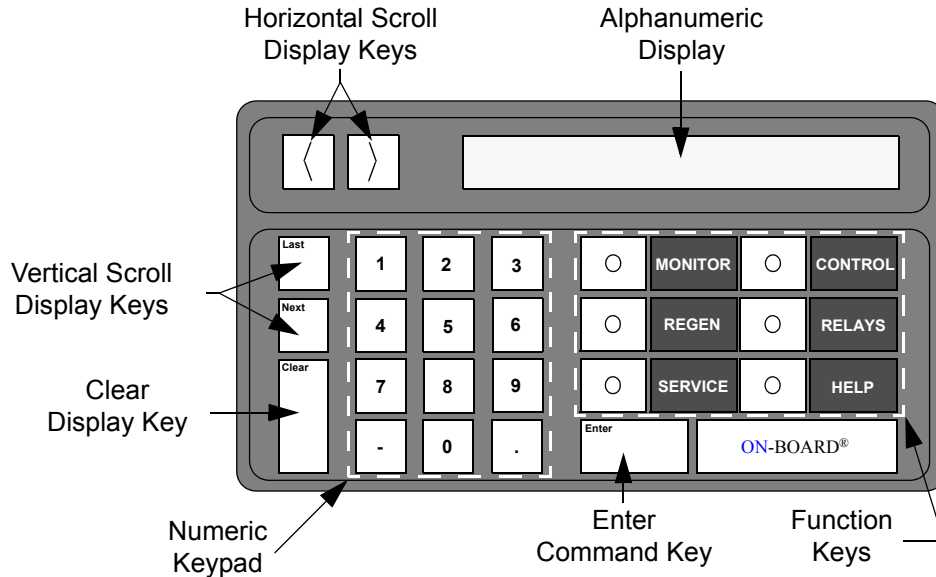

Figure 1-1: On-Board Keypad/Display

Alphanumeric Display

The alphanumeric display shows up to 16 alphanumeric characters of data entry. Messages longer than 16 characters can be viewed by using the horizontal scroll display key.

Horizontal Scroll Display Keys

The horizontal scroll display keys move the message to the left or right on the alphanumeric display when pressed. These keys are typically used to display a message which is longer than the 16 character width of the display.

Vertical Scroll Display Keys (Last, Next)

The last and next keys allow you to display the preceeding or proceeding messages of the respective Module software. Refer to the flowcharts in **Section 3 - Programming and Operation** for more information on the messages.

Clear Display Key

The clear key is used to remove user entered information during On-Board Module programming or device selection.

***NOTE:** The Clear key must be pressed before the Enter key is pressed to remove the desired information.*

Numeric Keypad

The numeric keypad is used to enter numeric values for On-Board Module programming and operation.

Enter Command Key

The enter key is used to accept numeric information which you have entered via the numeric keypad.

Function Keys

The function keys allow you to select the software function in which programming or operation is desired. Refer to **Section 3 - Programming and Operation** for more information on software functions.

On-line Help

The on-line HELP function provides you with additional information when used in conjunction with the MONITOR, REGEN, SERVICE, CONTROL and RELAYS function keys. Ranges of programmable values are displayed when the HELP key is pressed after the Enter key has been pressed. ON/OFF values are also displayed at appropriate times.

Instructions are also displayed for certain messages that appear on the screen. Figure 1-2 shows a help message that might be displayed, line by line, in the keypad/display when the HELP key is pressed during warm-up in the regeneration cycle.

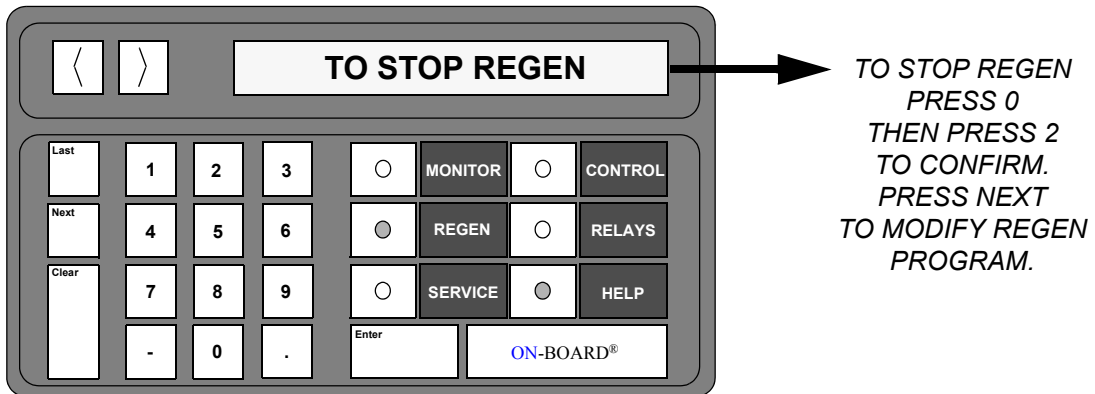

NOTE: After pressing the HELP key, press the Next key to display the help message line by line.

Figure 1-2: On-line Help Message Example

Software Version Identification

Refer to the SERVICE Function within **Section 3 - Programming and Operation** of this manual to identify the On-Board Module serial number and the software version.

Section 2 - System Power

Before You Start

Make sure the On-Board Cryopump has been installed according to the directions found in the **On-Board Cryopump Installation and Service Instructions** manual included with your cryopump.

Starting the Cryopump

1. Turn the On-Board ON/OFF switch, located on the compressor, to the ON position.
2. Turn the compressor ON/OFF switch to the ON position.
3. Turn the roughing pump ON.
4. Ensure that the nitrogen or air supply to the roughing valve is between 60 - 80 psig.
5. Ensure that the nitrogen supply to the purge valve is between 40 - 80 psig. Do *not* exceed 80 psig.

***NOTE:** The On-Board FastRegen Control Module comes programmed with the default values as shown in Table 3-1.*

6. Program the regeneration parameters to your particular values as described in **Section 3 - Programming and Operation** or use the default regeneration values.
7. Perform a Full regeneration cycle as described in **Section 3 - Programming and Operation**.

Shutting Down the Cryopump

1. Close the hi-vac valve, if there is one located between the cryopump and the vacuum system.
2. Press the **REGEN** key on the keypad/display.
3. Press **1** to start the regeneration cycle.
4. Press **2** to confirm the start of the regeneration cycle.
5. Once the cryopump temperature reaches 310K, press **0** to abort the REGEN cycle.
6. Press **2** to confirm the REGEN abort.

System Power

7. Turn the On-Board ON/OFF switch, located on the compressor, to the OFF position.
8. Turn the compressor ON/OFF switch to the OFF position.
9. Turn the roughing pump OFF.

Section 3 - Programming and Operation

Introduction

Section 3 provides you with a description of programming and operation information for On-Board FastRegen Control Module software. Refer to Table 3-5 at the end of this section for a complete list of all On-Board FastRegen Control Module software parameters.

Normal Operation

The On-Board Cryopump has been designed to operate without user assistance. However, the helium supply pressure gauge on the compressor should be checked once per week. Make sure the gauge reading is within the specified range as discussed in the appropriate compressor manual.

CAUTION

Refer to **Appendix A** and contact the local customer support center location whenever the helium supply gauge reading is not within the specified range.

MONITOR Function

The MONITOR function allows you to observe the following On-Board Cryopump system data:

- ON/OFF status of the On-Board Cryopump
- First and second stage temperature
- Cryo and auxiliary thermocouple gauge (TC) vacuum pressures
- ON/OFF status of programmable relays 1 and 2

***NOTE:** Data can only be displayed while using the MONITOR function.*

Data that is displayed using the MONITOR function is useful in determining the operating status of the On-Board Cryopump. The flowchart in Figure 3-1 displays all FastRegen Control Module MONITOR software functions.

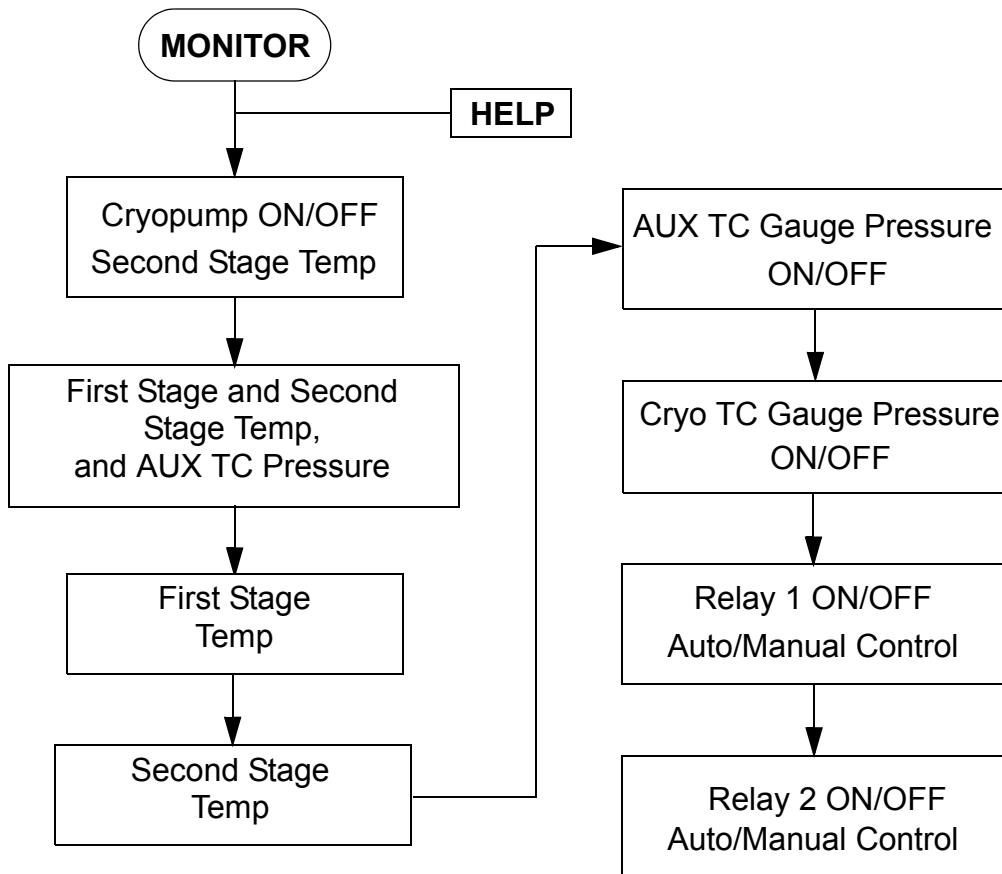

Figure 3-1: MONITOR Function Flowchart

Cryopump ON/OFF and Second Stage Temperature

The first parameter within the MONITOR function displays the On-Board Cryopump ON/OFF status and the second stage temperature (degrees Kelvin) as shown in Figure 3-2.

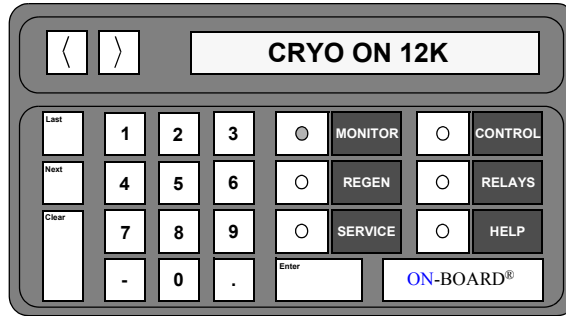

Figure 3-2: ON/OFF Status and Second Stage Temperature

***NOTE:** Refer to **Appendix A** and contact the local CTI-CRYOGENICS customer support center if the letters SHO or OPN are displayed.*

First and Second Stage Temperature and Auxiliary Thermocouple Pressure

The second parameter of the MONITOR function displays the On-Board Cryopump first and second stage temperature (degrees Kelvin) and the vacuum pressure of the auxiliary thermocouple gauge (microns) as shown in Figure 3-3. The display indicates pressures between 0 - 999 microns. The display indicates OFF when the thermocouple gauge is turned OFF.

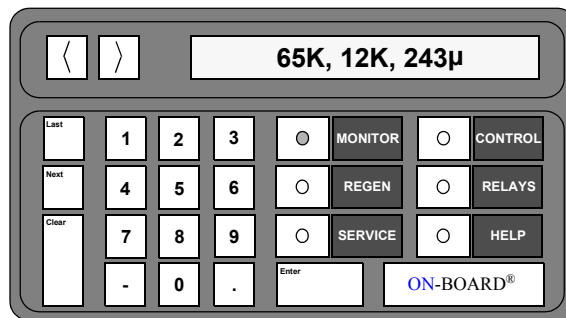

Figure 3-3: First and Second Stage Temperature and Auxiliary Thermocouple Pressure

First Stage Temperature in Kelvin

The third parameter of the MONITOR function displays the On-Board Cryopump first stage temperature (degrees Kelvin) as shown in Figure 3-4.

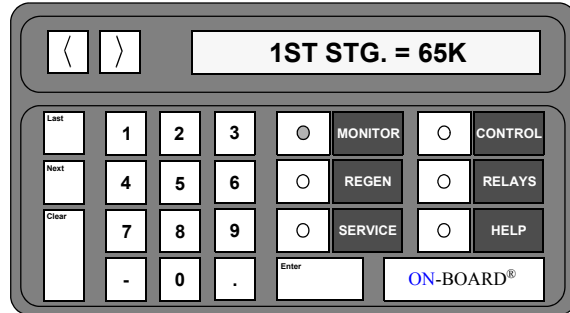

Figure 3-4: First Stage Temperature

Second Stage Temperature in Kelvin

The fourth parameter of the MONITOR function displays the On-Board Cryopump second stage temperature (degrees Kelvin) as shown in Figure 3-5.

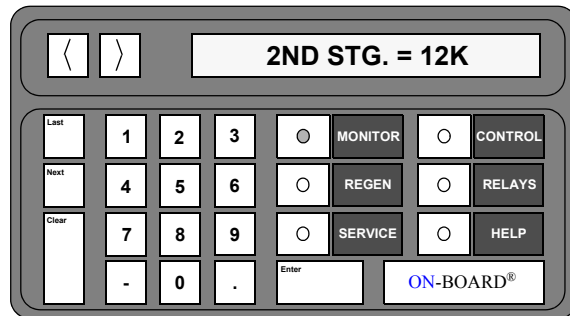

Figure 3-5: Second Stage Temperature

Auxiliary Thermocouple Gauge Pressure

The fifth parameter of the MONITOR function displays the auxiliary thermocouple gauge pressure (in microns) when turned ON, and indicates when the gauge is turned OFF. Refer to Figure 3-6. The display indicates pressures between 0 - 999 microns.

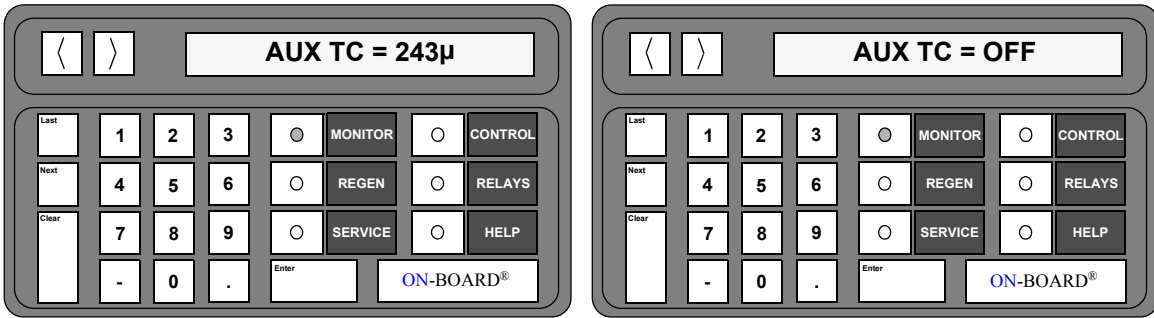

Figure 3-6: Auxiliary Thermocouple Gauge Pressure

Cryo Thermocouple Gauge Pressure

The sixth parameter of the MONITOR function displays the cryopump thermocouple gauge pressure (in microns) when turned ON, and indicates when the gauge is turned OFF if the cryopump is equipped with a thermocouple gauge. Refer to Figure 3-7. The display indicates pressures between 0 - 999 microns.

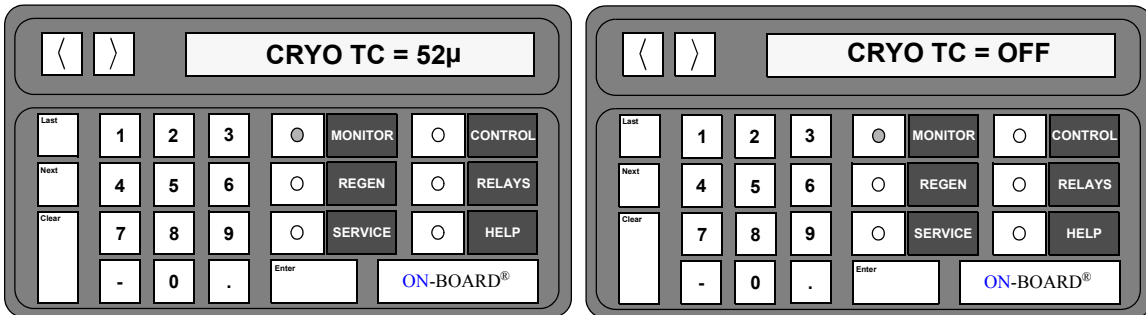

Figure 3-7: Cryo Thermocouple Gauge Pressure

Relay 1 ON/OFF and Auto/Manual Control

The seventh parameter of the MONITOR function displays the ON/OFF status of Relay 1 and whether Relay 1 is in automatic or manual control. Refer to Figure 3-8.

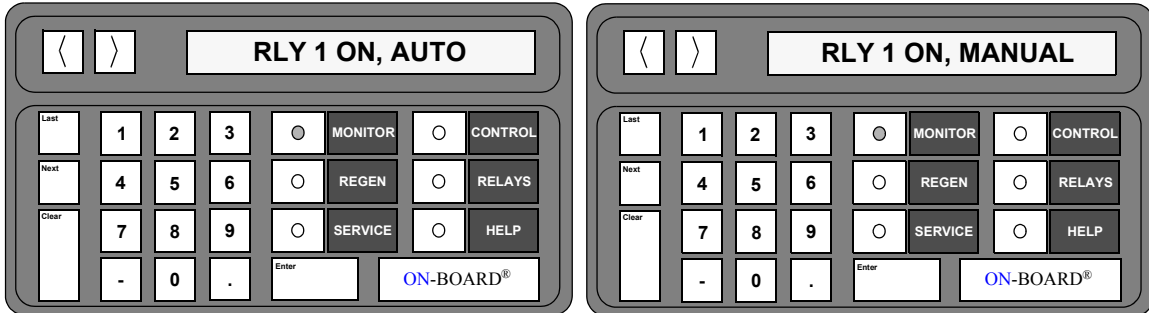

Figure 3-8: Relay 1 Automatic or Manual Control

Relay 2 ON/OFF and Auto/Manual Control

The eighth parameter of the MONITOR function displays the ON/OFF status of Relay 2 and whether Relay 2 is in automatic or manual control. Refer to Figure 3-9.

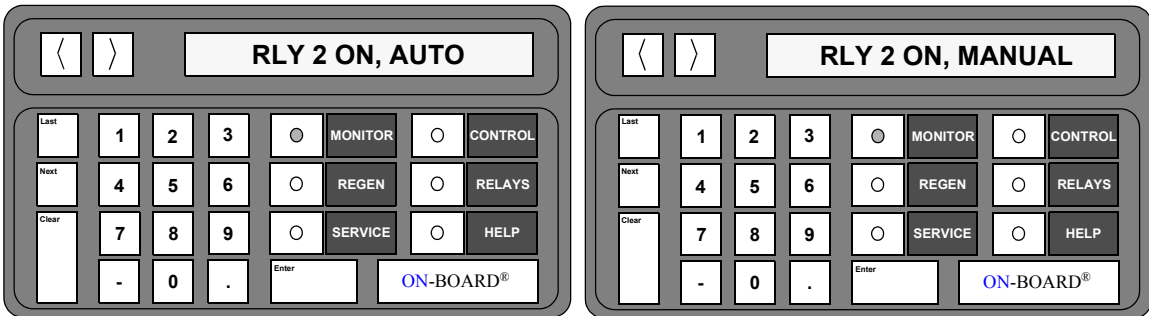

Figure 3-9: Relay 2 Automatic or Manual Control

MONITOR Function Operation

Use the following procedure to observe the MONITOR function parameters of the On-Board FastRegen Control Module.

NOTE: *The On-Line HELP function is always available for use during the operation of the MONITOR function. Refer to **Section 1 - Basic On-Board Module Information** for more information.*

1. Press the **MONITOR** key on the keypad/display. The MONITOR key illuminates, the cryopump ON/OFF status and the second stage temperature are displayed.

NOTE: *Refer to **Appendix A** and contact the local CTI-CRYOGENICS customer support center if the letters SHO or OPN are displayed.*

2. Press the **Next** key. The first and second stage temperatures are displayed in degrees Kelvin and the auxiliary thermocouple gauge pressure is displayed in microns.
3. Press the **Next** key. The first stage temperature is displayed in degrees Kelvin.
4. Press the **Next** key. The second stage temperature is displayed in degrees Kelvin.
5. Press the **Next** key. The auxiliary thermocouple gauge pressure is displayed in microns (if available).
6. Press the **Next** key. The cryopump thermocouple gauge pressure is displayed in microns.
7. Press the **Next** key. The ON/OFF status of Relay 1 is displayed along with the automatic or manual mode indicator.
8. Press the **Next** key. The ON/OFF status of Relay 2 is displayed along with the automatic or manual mode indicator.

Regeneration Function

The REGEN function of the On-Board FastRegen Control Module allows you to initiate a Full or Fast regeneration cycle on your cryopump. Once initiated, the On-Board System automatically sequences your pump through the various phases of the regeneration cycle.

A Full regeneration cycle allows the cryopump to warm-up to room temperature so that both gases and water vapor collected on the arrays are purged from the pump. Once the contaminants are purged, the cryopump becomes cold again.

In many cases, there is little water pumped and so it is not necessary to warm the pump to room temperature. If the pump is primarily filled with such gases as argon, nitrogen or hydrogen, then the pump can be regenerated using a Fast Regeneration cycle. A Fast regeneration cycle only warms the cryopump enough to release the gases condensed on the arrays and trapped within the charcoal. This allows the regeneration cycle to be completed in less than an hour in many cases.

One of the key process steps in a Fast regeneration cycle is the removal of the condensed gas by means of the roughing pump. It is important that the condensed gas be removed quickly as the pump warms up, and that a certain minimum base pressure in the cryopump be achieved quickly. Because of these requirements, it is necessary that cryopumps that share a common roughing pump be coordinated. That is, the start of regeneration, the opening and closing of the roughing valves and the purge valves on multi-pump On-Board Cryopump systems must happen at very specific times and in unison. These are coordinated by the Network Terminal. The roughing valves are coordinated by the Network Terminal for both Fast and Full regeneration cycles although for different reasons.

NOTE: Refer to the Network Terminal Installation, Operation and Maintenance Instruction manual CTI-CRYOGENICS P/N 8040375G001 for Network Terminal set-up and operating instructions for multi-pump regeneration cycles.

Typically, regeneration is a function that is part of overall periodic maintenance for a cryopump system: frequency is dependent upon your particular pump application, but the cycle can be manually started at any time.

The REGEN program incorporates a number of parameters that are preset at the factory, such as RATE-OF-RISE (10u/min.) and default base pressure (50 microns). The On-Board FastRegen Control Module allows you to reprogram the settings, within limits. This is normally done prior to the start of a regeneration cycle. The On-Board FastRegen Control Module also allows you to delay that start and completion of regeneration cycle. This feature is desirable, for example, when you want to regenerate and start up your cryopump system during a week-end shutdown. You can reset the REGEN parameters by pressing the REGEN key and stepping through the REGEN menu as shown in Table 3-1.

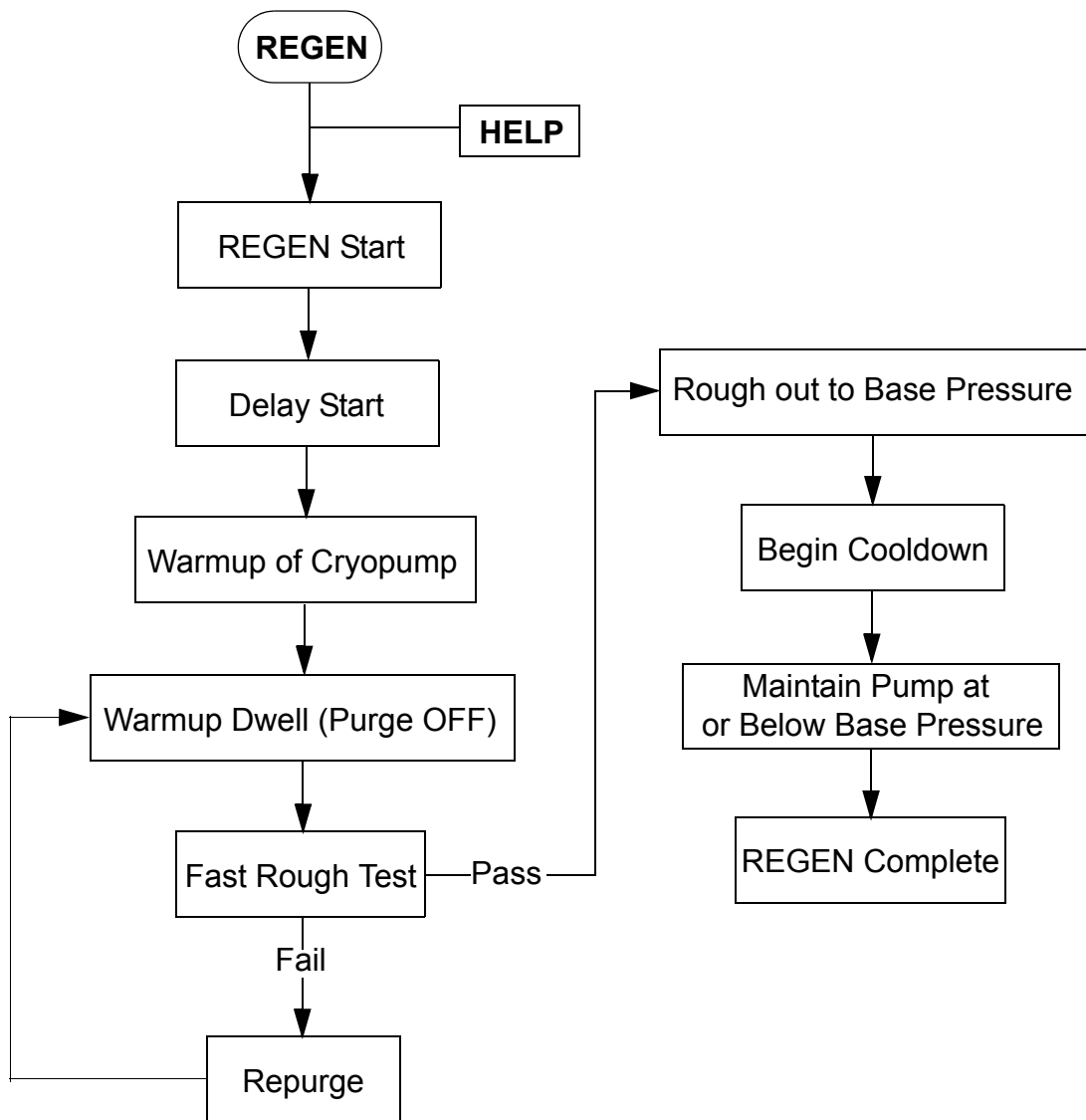

Figure 3-10: Fast Regeneration Cycle Function Flowchart

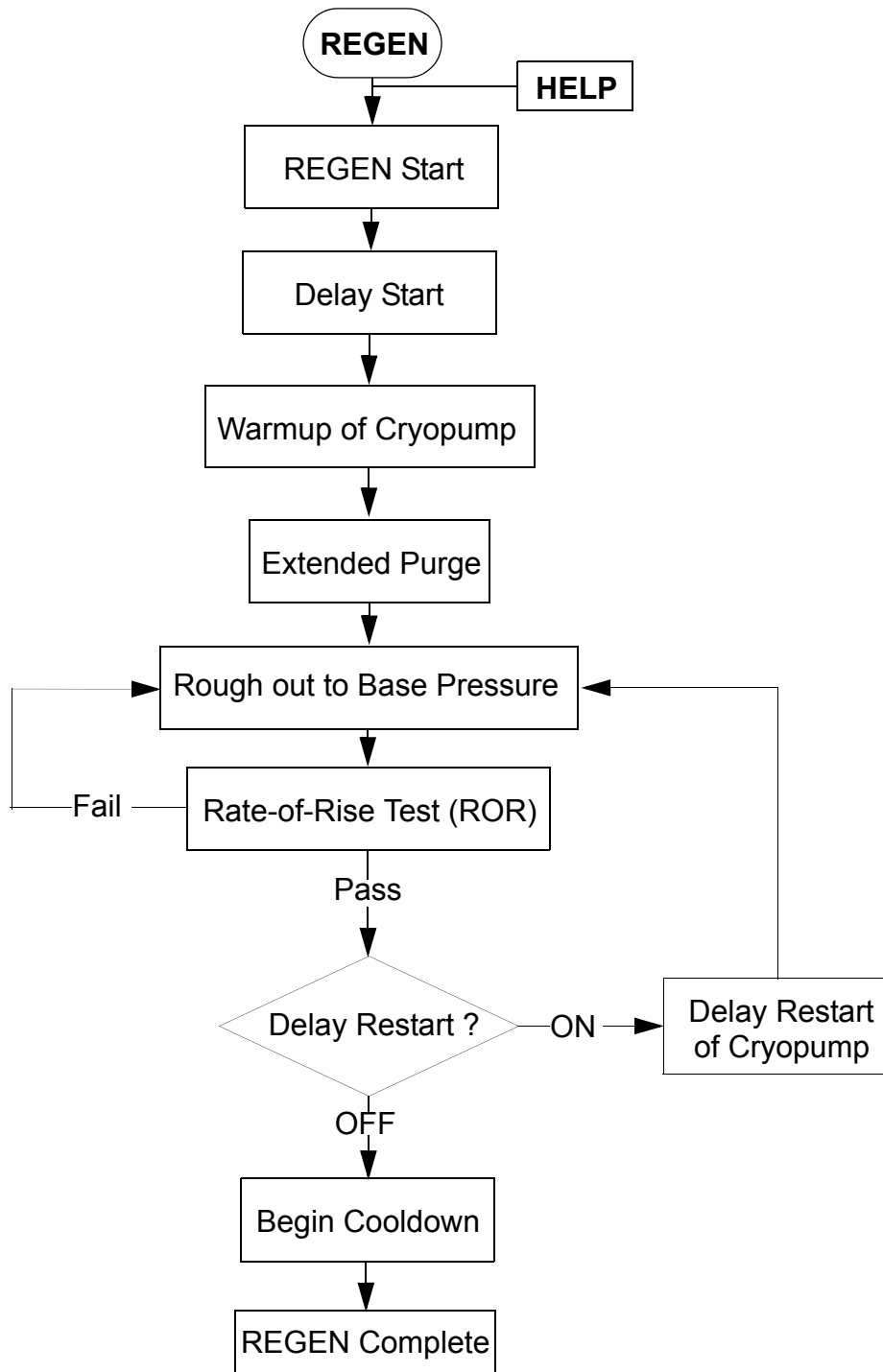

Figure 3-11: Full Regeneration Cycle Function Flowchart

Table 3-1: REGEN Function Parameters

REGEN Parameter	Default Value	Range of Values	Fast	Full
REGEN ON/OFF	OFF	ON/OFF	-	-
Delay Start	0	0 - 999.9 hours	X	X
Delay Restart	0	0 - 999.9 hours		X
Fast Rough Test (sputter)	150 seconds	10 - 999 seconds	X	
Fast Rough Test (implanter)	500 seconds	10 - 999 seconds	X	
Extended Purge	10 minutes	0 - 9999 minutes		X
Repurge	10 minutes	0 - 9999 minutes		X
Repurge Cycles	20	0 - 20 cycles		X
Base Pressure	50 microns	25 - 200 microns	X	X
Rate-of-Rise (ROR)	10 microns/minute	1 -100 microns/minute		X
ROR Cycles	20	0 - 40 cycles		X
Rough Valve Interlock	OFF	ON/OFF	X	X
Power Fail Recovery	OFF	ON/OFF/COOL	X	X
Power Fail Recovery Temperature	25K	0 - 80K	X	X

NOTE: The Fast and Full columns in Table 3-1 indicate whether the regeneration parameters are used during the Fast and/or Full regeneration cycles.

REGEN ON/OFF

The first parameter of the REGEN function allows you to initialize a Fast or Full regeneration routine. Initially, the current REGEN status is displayed. Once the *CONFIRM START* message has been displayed, press 2 to start a Full regeneration cycle, or, press 3 to start a Fast regeneration cycle. The time to complete a REGEN cycle is dependent upon the cryopump application. The keypad/display messages are shown in Figure 3-12.

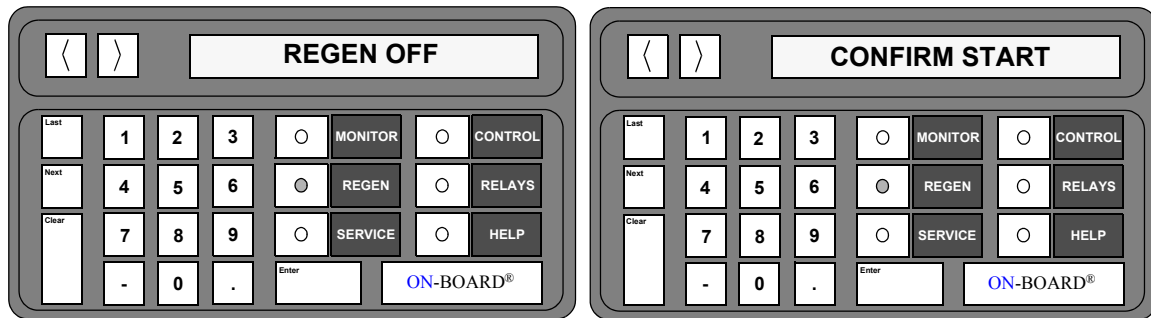

Figure 3-12: REGEN ON/OFF Display

Delay Start

The second parameter of the REGEN function allows you to delay the start of either a Fast or Full regeneration cycle. You simply enter the amount of delay time, as shown in Figure 3-13, and the On-Board Cryopump waits that amount of time before starting the regeneration cycle you selected.

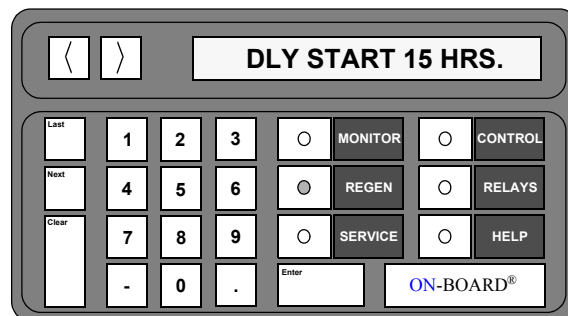

Figure 3-13: Delay Start of Regeneration Display

Delay Restart

The third parameter of the REGEN function allows you to delay the restart of the Full regeneration cycle, if desired. Once the time delay has expired, the cryopump is roughed out again (if applicable) and is cooled down. The Delay Restart display is shown in Figure 3-14.

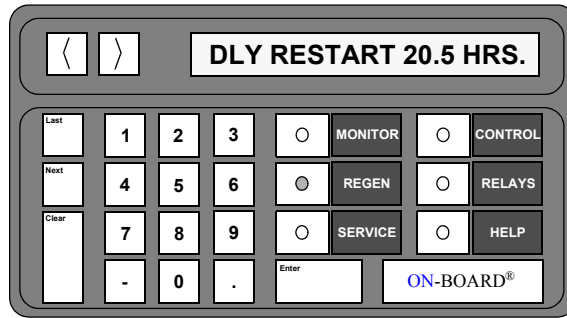

Figure 3-14: Delay Restart Display

Fast Rough Test

The fourth parameter of the REGEN function allows you to determine the fast rough test time which checks to see whether or not Argon has been eliminated from the cryopump during a Fast regeneration as shown in Figure 3-15. If during the rough test, the pressure does not drop below 1000 microns, before the fast rough time has expired, then the cryopump will automatically go into a repurge cycle.

NOTE: *In the case of implanters, the pump typically will not contain liquid cryogenes and therefore will not have to repurge to boil off the liquid. If an implanter pump fails the fast rough test, the pump will automatically go back into the fast rough test cycle.*

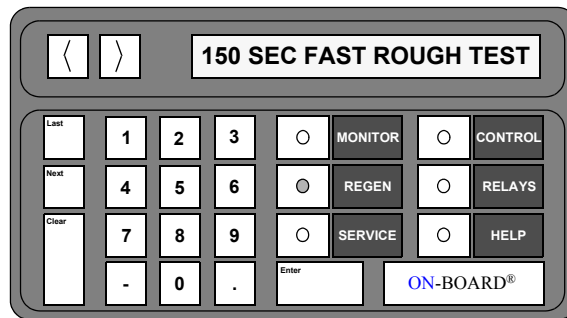

Figure 3-15: Fast Rough Test Display

Extended Purge

The fifth parameter of the REGEN function allows you to extend the purge time during Full regeneration to ensure the cryopump has been purged of all contaminants. The extended purge time screen display is shown in Figure 3-16.

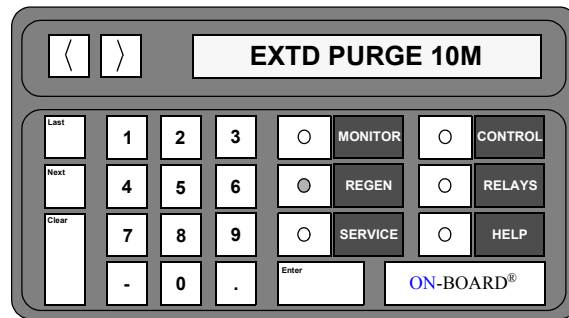

Figure 3-16: Extended Purge Display

Repurge

The sixth parameter of the REGEN function allows you to establish the repurge time in the event of repurge as shown in Figure 3-17. A repurge occurs during Full regeneration when the roughing pressure fails to decrease at a rate of at least 2% per minute.

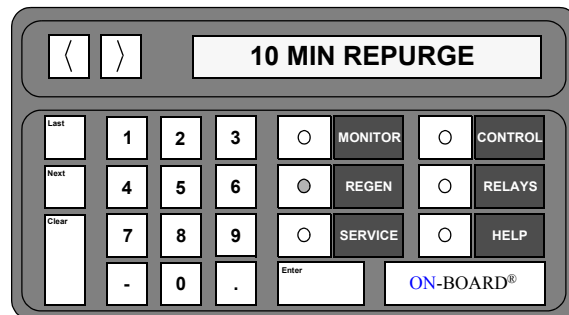

Figure 3-17: Repurge Display

Repurge Cycles

The seventh parameter of the REGEN function allows the user to determine the number of repurge cycles that are performed during a Full regeneration if the pump fails to rough out to the user determined base pressure as shown in Figure 3-18. Regeneration is aborted after this limit is reached.

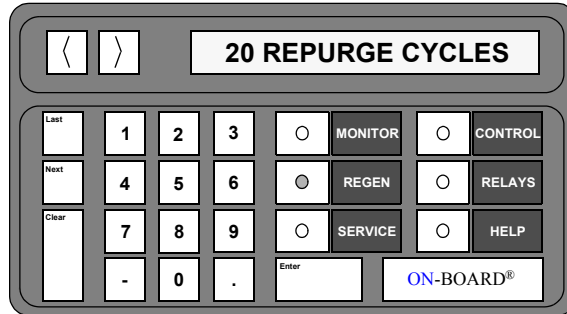

Figure 3-18: Repurge Cycles Display

Base Pressure

The eighth parameter of the REGEN function allows you to establish the base pressure to be reached when roughing a cryopump during either a Fast or Full regeneration. The Base Pressure display is shown in Figure 3-19.

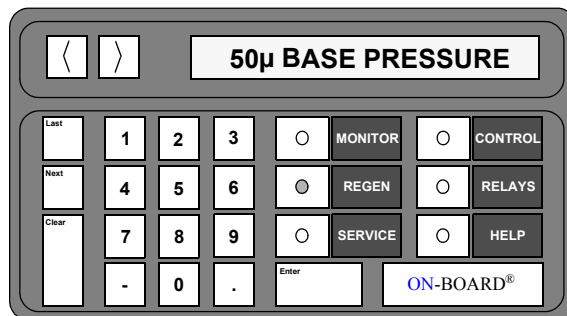

Figure 3-19: Base Pressure Display

Rate-of-Rise

The ninth parameter of the REGEN function allows you to establish the micron/minute rate in which the Rate-of-Rise (ROR) test is performed during a Full regeneration. The ROR display is shown in Figure 3-20.

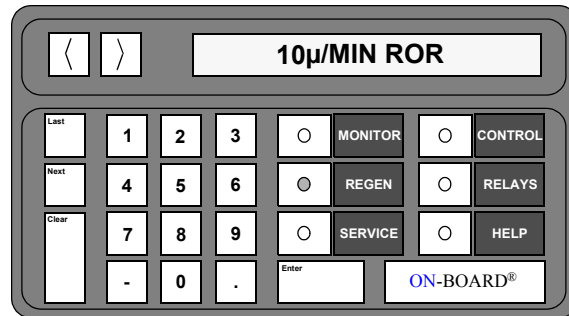

Figure 3-20: Rate-of-Rise Display

ROR Cycles

The tenth parameter of the REGEN function allows you to establish the number of times the ROR test can be performed before the Full regeneration cycle is aborted. The ROR Cycles display is shown in Figure 3-21.

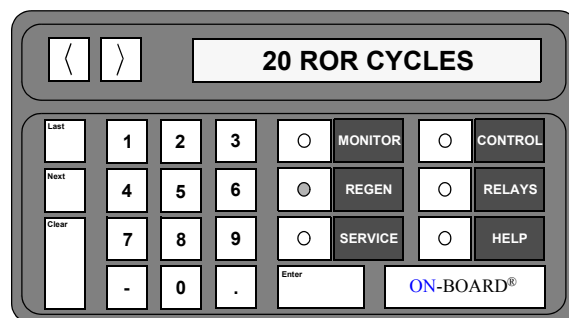

Figure 3-21: ROR Cycles Display

Rough Valve Interlock

The eleventh parameter of the REGEN function allows the On-Board roughing valve to operate independent of the rough valve grouping when Rough Valve Interlock is set to OFF (0). The Rough Valve Interlock display is shown in Figure 3-22. When the rough valve interlock is ON, the rough valve will open during regeneration when permission is received from the Network Terminal.

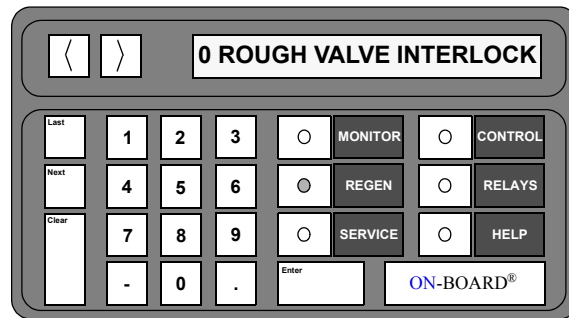

Figure 3-22: Rough Valve Interlock Display

Power Fail Recovery

The twelfth parameter of the REGEN function allows the On-Board cryopump to automatically perform a REGEN cycle, or to cool down if below the power failure recovery temperature, after a power failure has occurred, as shown in Figure 3-23. There are three settings available to you:

- 0 - Power Fail OFF
- 1 - Power Fail ON
- 2 - Power Fail Cool

NOTE: *If Power Fail Cool is selected, and the power failure occurs while the cryopump is ON, the cryopump will only cool down if it is below the power fail recovery temperature setpoint. If the cryopump temperature is above the setpoint, the cryopump will remain OFF.*

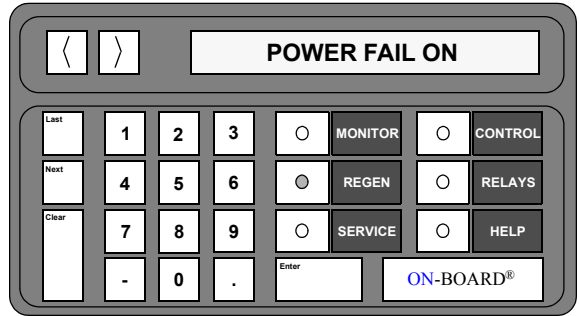

Figure 3-23: Power Fail Recovery Display

Power Fail Recovery Temperature

The thirteenth parameter of the REGEN function allows you to establish a temperature setpoint which the On-Board Cryopump uses to decide whether to cool down, or to perform a Full regeneration cycle after a power failure has occurred and power is restored. Refer to Figure 3-24.

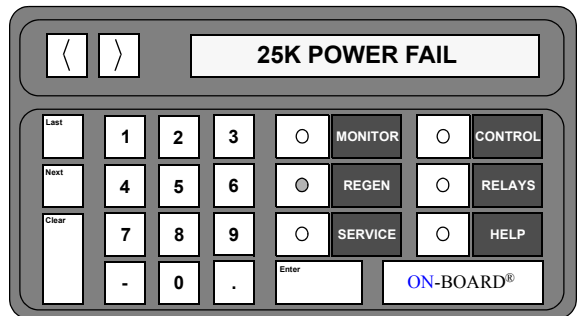

Figure 3-24: Power Fail Recovery Temperature Display

REGEN Function Programming

Use the following procedures to program individual REGEN function parameters of the On-Board FastRegen Control Module.

Initiate REGEN

1. Press the **REGEN** key on the keypad/display. The current REGEN status is displayed.
2. Press **1** to initiate a regeneration cycle.
3. Press **2** to confirm the start of a Full regeneration cycle.
4. Press **3** to confirm the start of a Fast regeneration cycle.

Abort REGEN

1. Press the **REGEN** key on the keypad/display. The current REGEN status is displayed.
2. Press **0** to abort a regeneration cycle.
3. Press **2** to confirm the end of a regeneration cycle.

Delay Start

1. Press the **REGEN** key on the keypad/display. The current REGEN status is displayed.
2. Press the **Next** key. The current delay start time value is displayed in hours.
3. Press the **Enter** key. The current value is underlined and ready to accept a new value.
4. Press the numeral keys for the desired delay time. For example: **1, 5** for 1.5, or **1, 5, and 0** for 15.0. The range of values is 0 - 999.9 hours.

***NOTE:** The Clear key may be pressed if incorrect data has been entered. The On-Board software allows you to enter the new value.*

5. Press the **Enter** key. Delay start programming is complete.
6. Press the **MONITOR** key. The On-Board microprocessor will monitor system operation.

Delay Restart

1. Press the **REGEN** key on the keypad/display. The current REGEN status is displayed.
2. Press the **Next** key until the current delay restart time value is displayed in hours.
3. Press the **Enter** key. The current value is underlined and ready to accept a new value.
4. Press the numeral keys for the desired delay time. For example: **1**, **5** for 1.5, or **1**, **5**, and **0** for 15.0. The range of values is 0 - 999.9 hours.

***NOTE:** The Clear key may be pressed if incorrect data has been entered. The On-Board software allows you to enter the new value.*

5. Press the **Enter** key. Delay restart programming is complete.
6. Press the **MONITOR** key. The On-Board microprocessor will monitor system operation.

Fast Rough Test

1. Press the **REGEN** key on the keypad/display. The current REGEN status is displayed.
2. Press the **Next** key until the current fast rough test value is displayed in seconds.
3. Press the **Enter** key. The current value is underlined and ready to accept a new value.
4. Press the numeral keys for the desired fast rough test time. For example: **1**, **5**, and **0** for 15.0. The range of values is 10 - 999 seconds.

***NOTE:** The Clear key may be pressed if incorrect data has been entered. The On-Board software allows you to enter the new value.*

5. Press the **Enter** key. Fast rough test programming is complete.
6. Press the **MONITOR** key. The On-Board microprocessor will monitor system operation.

Extended Purge

1. Press the **REGEN** key on the keypad/display. The current REGEN status is displayed.
2. Press the **Next** key until the extended purge value is displayed in minutes.
3. Press the **Enter** key. The current value is underlined and ready to accept a new value.
4. Press the numeral keys for the desired extended purge time. For example: **1**, **5**, and **0** for 15.0. The range of values is 0 - 9999 minutes.

***NOTE:** The Clear key may be pressed if incorrect data has been entered. The On-Board software allows you to enter the new value.*

5. Press the **Enter** key. Extended purge programming is complete.
6. Press the **MONITOR** key. The On-Board microprocessor will monitor system operation.

Repurge

1. Press the **REGEN** key on the keypad/display. The current REGEN status is displayed.
2. Press the **Next** key until the repurge value is displayed in minutes.
3. Press the **Enter** key. The current value is underlined and ready to accept a new value.
4. Press the numeral keys for the desired repurge time. For example: **1**, **5**, and **0** for 15.0. The range of values is 0 - 9999 minutes.

***NOTE:** The Clear key may be pressed if incorrect data has been entered. The On-Board software allows you to enter the new value.*

5. Press the **Enter** key. Repurge programming is complete.
6. Press the **MONITOR** key. The On-Board microprocessor will monitor system operation.

Repurge Cycles

1. Press the **REGEN** key on the keypad/display. The current REGEN status is displayed.
2. Press the **Next** key until the current number of repurge cycles is displayed.

3. Press the **Enter** key. The current value is underlined and ready to accept a new value.
4. Press the numeral keys for the desired number of repurge cycles. For example: **1, 5** for 15. The range of values is 0 - 20 cycles.

***NOTE:** The Clear key may be pressed if incorrect data has been entered. The On-Board software allows you to enter the new value.*

5. Press the **Enter** key. Repurge cycles programming is complete.
6. Press the **MONITOR** key. The On-Board microprocessor will monitor system operation.

Base Pressure

1. Press the **REGEN** key on the keypad/display. The current REGEN status is displayed.
2. Press the **Next** key until the current base pressure value is displayed in microns.
3. Press the **Enter** key. The current value is underlined and ready to accept a new value.
4. Press the numeral keys for the desired base pressure. For example: **3, 5**, for 35. The range of values is 25 - 200 microns.

***NOTE:** The Clear key may be pressed if incorrect data has been entered. The On-Board software allows you to enter the new value.*

5. Press the **Enter** key. Base pressure programming is complete.
6. Press the **MONITOR** key. The On-Board microprocessor will monitor system operation.

Rate-of-Rise (ROR)

1. Press the **REGEN** key on the keypad/display. The current REGEN status is displayed.
2. Press the **Next** key until the current ROR value is displayed.
3. Press the **Enter** key. The current value is underlined and ready to accept a new value.
4. Press the numeral keys for the desired ROR value. For example: **1, 5** for 15. The range of values is 0 - 100 microns/minute.

***NOTE:** The Clear key may be pressed if incorrect data has been entered. The On-Board software allows you to enter the new value.*

5. Press the **Enter** key. ROR programming is complete.

6. Press the **MONITOR** key. The On-Board microprocessor will monitor system operation.

Rate-of-Rise (ROR) Cycles

1. Press the **REGEN** key on the keypad/display. The current REGEN status is displayed.
2. Press the **Next** key until the current value for the ROR cycles is displayed.
3. Press the **Enter** key. The current value is underlined and ready to accept a new value.
4. Press the numeral keys for the desired number of cycles. For example: **1, 5**, for 15. The range of values is 0 - 40 cycles.

***NOTE:** The Clear key may be pressed if incorrect data has been entered. The On-Board software allows you to enter the new value.*

5. Press the **Enter** key. ROR cycle programming is complete.
6. Press the **MONITOR** key. The On-Board microprocessor will monitor system operation.

Rough Valve Interlock

1. Press the **REGEN** key on the keypad/display. The current REGEN status is displayed.
2. Press the **Next** key until the current state for rough valve interlock is displayed.

***NOTE:** The rough valve interlock must be OFF when a cryopump is not being operated within a rough valve group. Otherwise, the rough valve will never open and the cryopump will remain in the rough share wait mode.*

3. Press the **Enter** key. The current value is underlined and ready to accept a new value.
4. Press the numeral keys to turn the rough valve interlock ON or OFF. The range of values is 1 (ON) or 0 (OFF).
5. Press the **Enter** key. Rough valve interlock programming is complete.
6. Press the **MONITOR** key. The On-Board microprocessor will monitor system operation.

Power Failure Recovery

1. Press the **REGEN** key on the keypad/display. The current REGEN status is displayed.
2. Press the **Next** key until the current mode for power failure recovery is displayed.
3. Press the desired numeral key to set power failure recovery to the desired mode. The range of values is 0 (OFF), 1 (ON), or 2 (Cool).
4. Press the **MONITOR** key. The On-Board microprocessor will monitor system operation.

***NOTE:** The Power Failure option only allows for a Full regeneration. If a Fast REGEN module has a power fail ON and power is lost, a Full regeneration will be performed.*

Power Failure Recovery Temperature

1. Press the **REGEN** key on the keypad/display. The current REGEN status is displayed.
2. Press the **Next** key until the current power failure recovery temperature is displayed.
3. Press the **Enter** key. The current value is underlined and ready to accept a new value.
4. Press the numeral keys for the desired recovery temperature. For example: **2**, and **5** for 25K. The range of values is 10 - 80K.

***NOTE:** The Clear key may be pressed if incorrect data has been entered. The On-Board software allows you to enter the new value.*

5. Press the **Enter** key. Power failure recovery temperature programming is complete.
6. Press the **MONITOR** key. The On-Board microprocessor will monitor system operation.

***NOTE:** In the event of a power failure, if the cryopump is ON and Power Failure Recovery is ON, and the cryopump warms up to a temperature higher than the temperature setpoint, the cryopump will be automatically regenerated. The display will read POWER FAILURE - REGENERATION.*

***NOTE:** If a Delay Start or Delay Restart has been programmed, these times will be ignored for regeneration initiated due to a power failure.*

NOTE: *If the cryopump temperature stays lower than the setpoint, the cryopump is restarted. The cryopump has 30 minutes for the second stage temperature to cool below 17K. If this temperature is not achieved, the display will read POWER FAILURE - CHECK CRYO TEMP.*

NOTE: *If the cryopump is in regeneration and is cooling, the cooling will continue if the thermocouple pressure is below 100 μ . If the cryopump is in any other phase of regeneration, or if the thermocouple pressure is above 100 μ , regeneration will start over again. If cooldown continues, the display will read POWER FAILURE - COOLDOWN.*

Performing a Fast or Full Regeneration Cycle

Make sure you program the REGEN function parameters to your desired values before attempting to perform a Fast or Full regeneration cycle.

Fast Regeneration Cycle

1. Press the **REGEN** key on the keypad/display. The current REGEN status is displayed.
2. Press **1** to initiate a regeneration cycle.
3. Press **3** to confirm the start of a Fast regeneration cycle. A Fast regeneration cycle has been initiated.

The On-Board FastRegen Control Module performs a Fast regeneration cycle according to the REGEN parameters you have programmed. Refer to Figure 3-10 for more information.

Full Regeneration Cycle

1. Press the **REGEN** key on the keypad/display. The current REGEN status is displayed.
2. Press **1** to initiate a regeneration cycle.
3. Press **2** to confirm the start of a Full regeneration cycle. A Full regeneration cycle has been initiated.

The On-Board FastRegen Control Module performs a Full regeneration cycle according to the REGEN parameters you have programmed. Refer to Figure 3-11 for more information.

REGEN Cycle Examples

The flowcharts in Figures 3-25 and 3-26 provide you with examples of the typical REGEN cycle for On-Board Cryopumps.

NOTE: The values in these examples are for discussion purposes only.

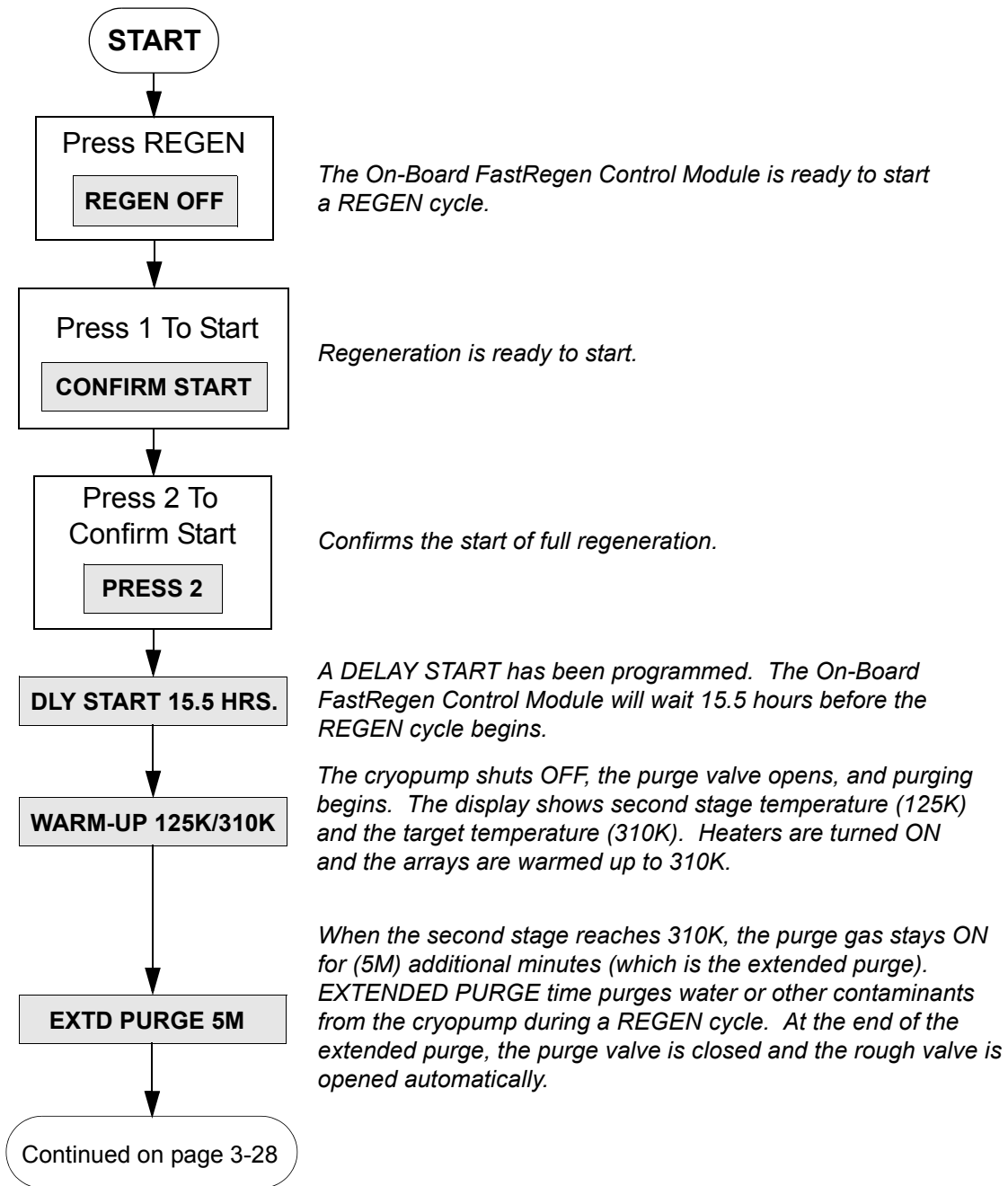

Figure 3-25: On-Board Cryopump Full Regeneration Cycle Example

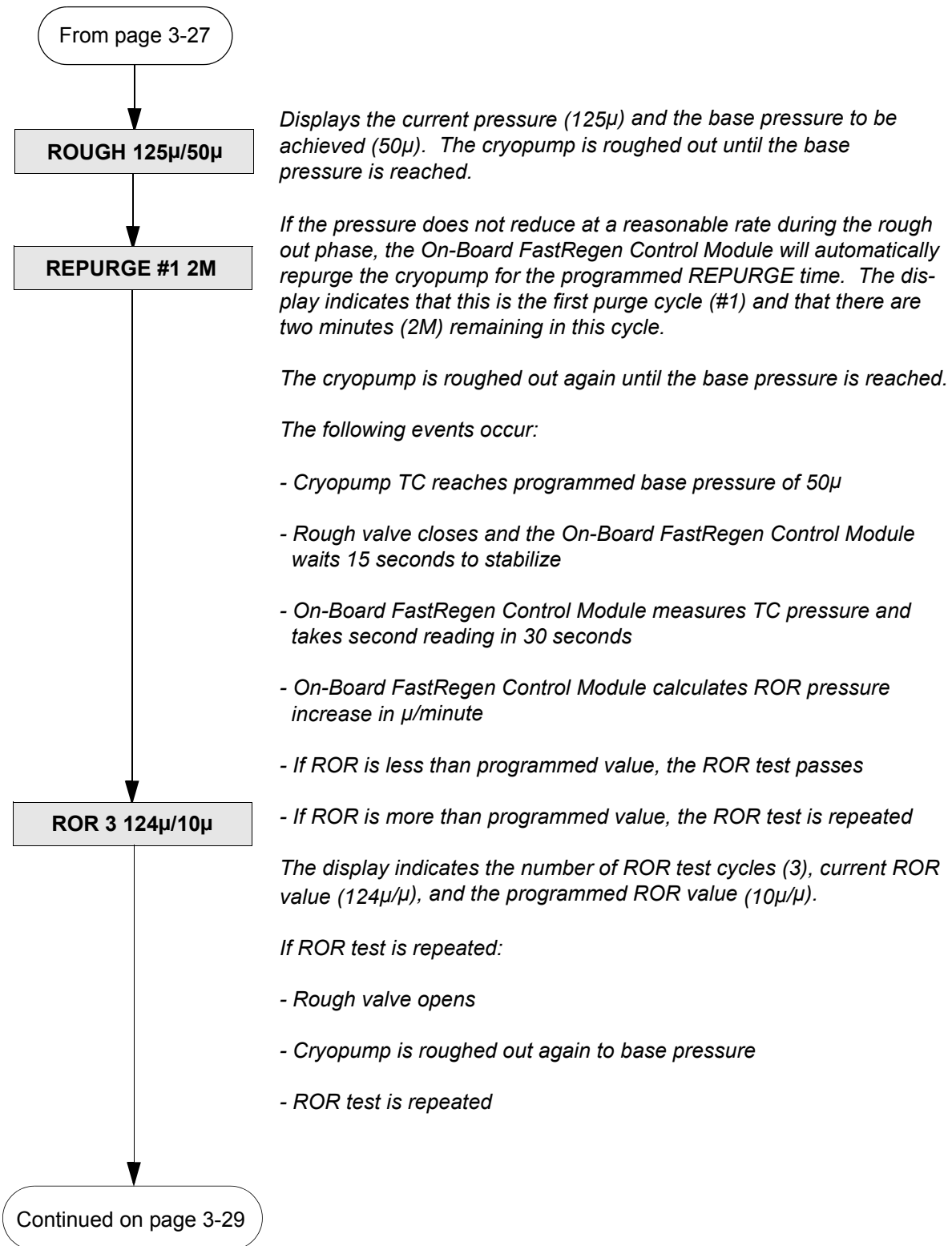

Figure 3-25: On-Board Cryopump Full Regeneration Cycle Example (continued)

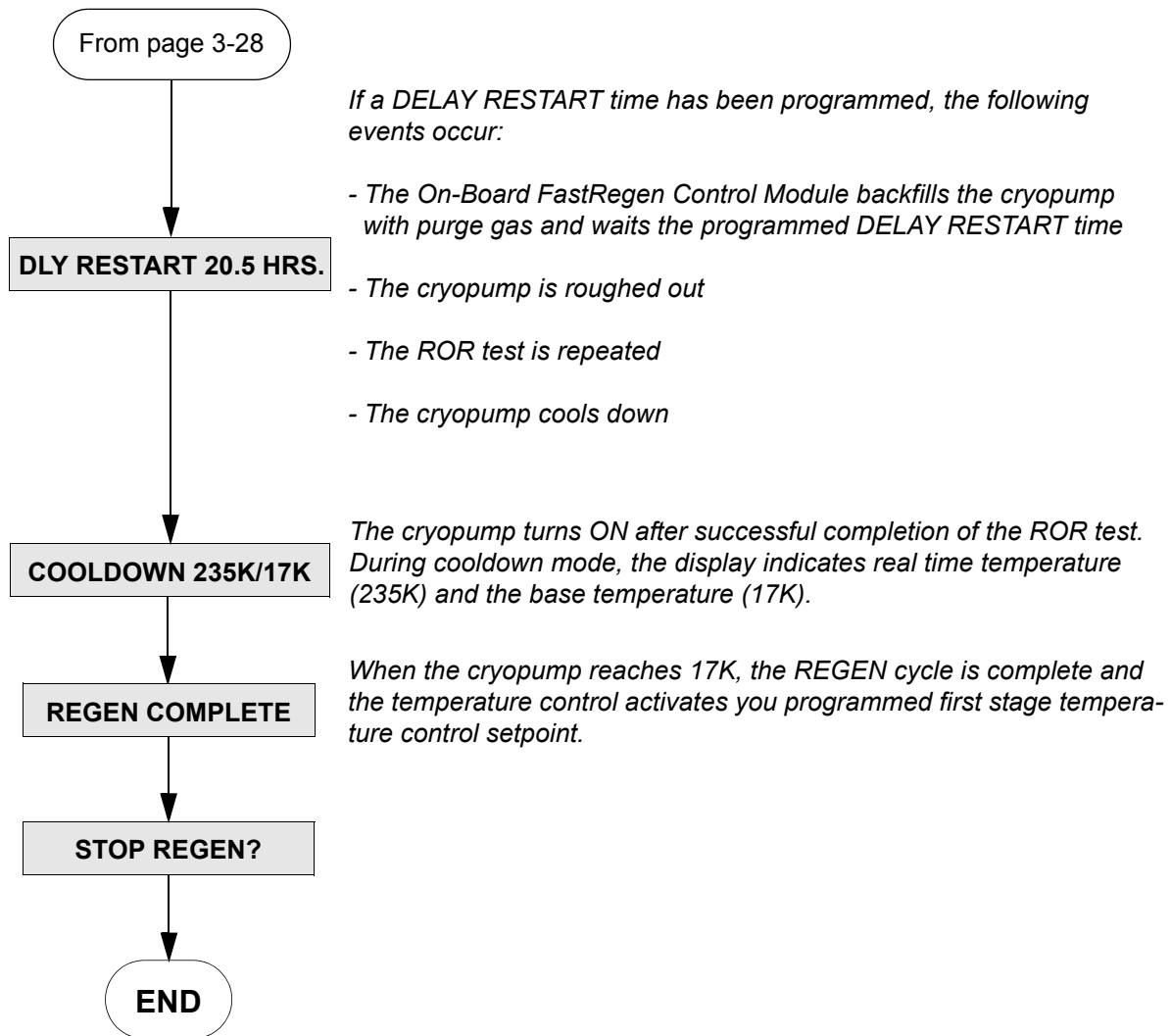
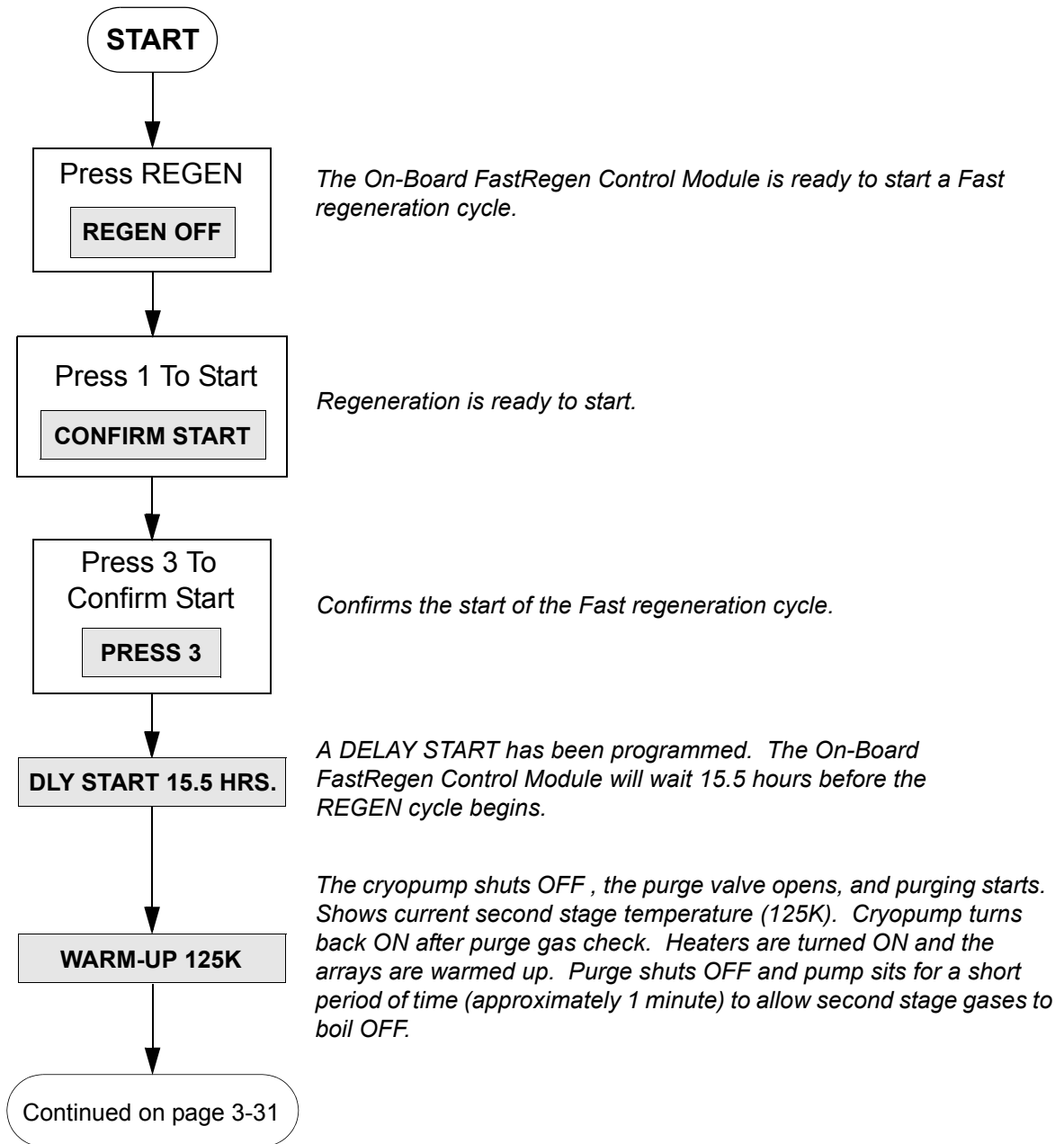

Figure 3-25: On-Board Cryopump Full Regeneration Cycle Example (continued)



NOTE: In the case of FastRegen Control Modules for Ion Implanters, several rough and purge cycles occur during the warmup phase. These cycles help remove hydrogen gas which may be present in the cryopump.

Figure 3-26: On-Board Cryopump Fast Regeneration Cycle Example

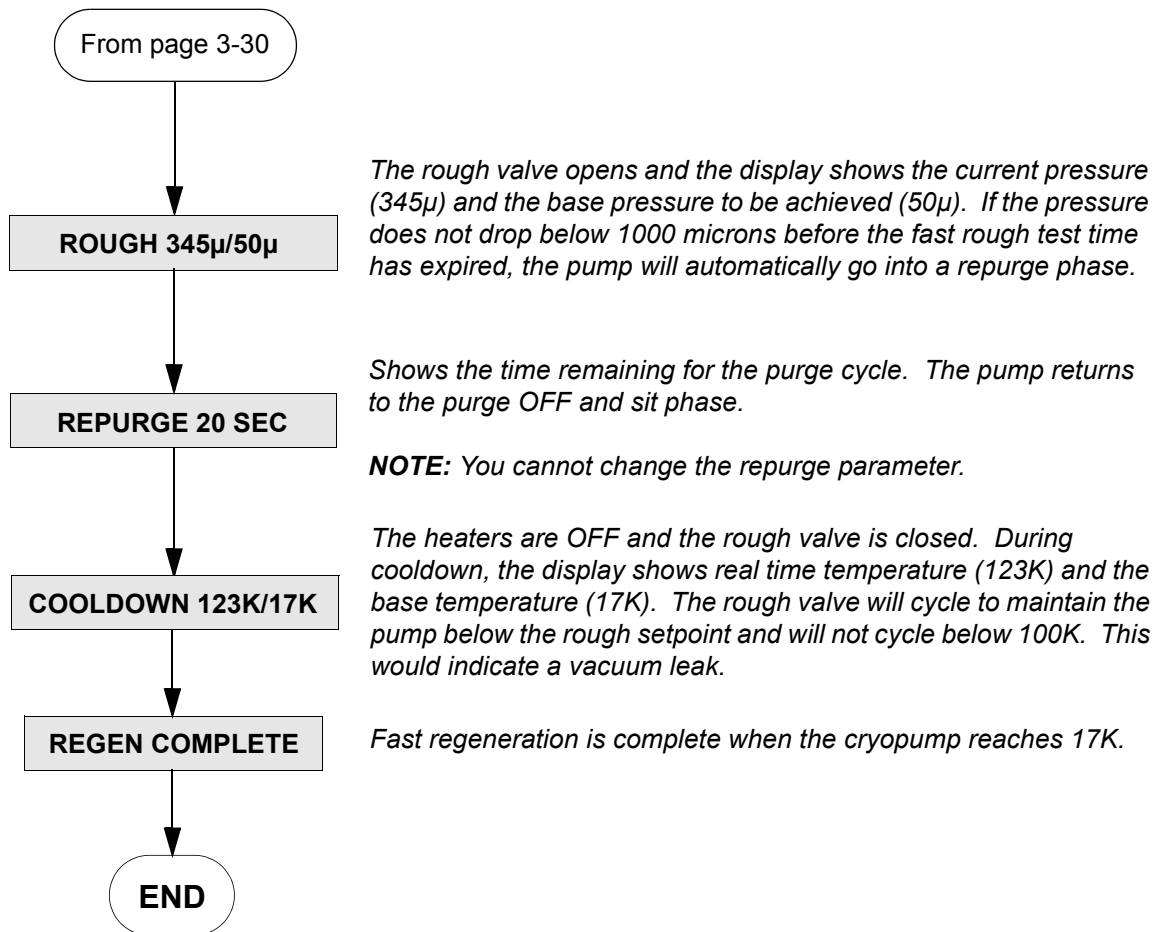
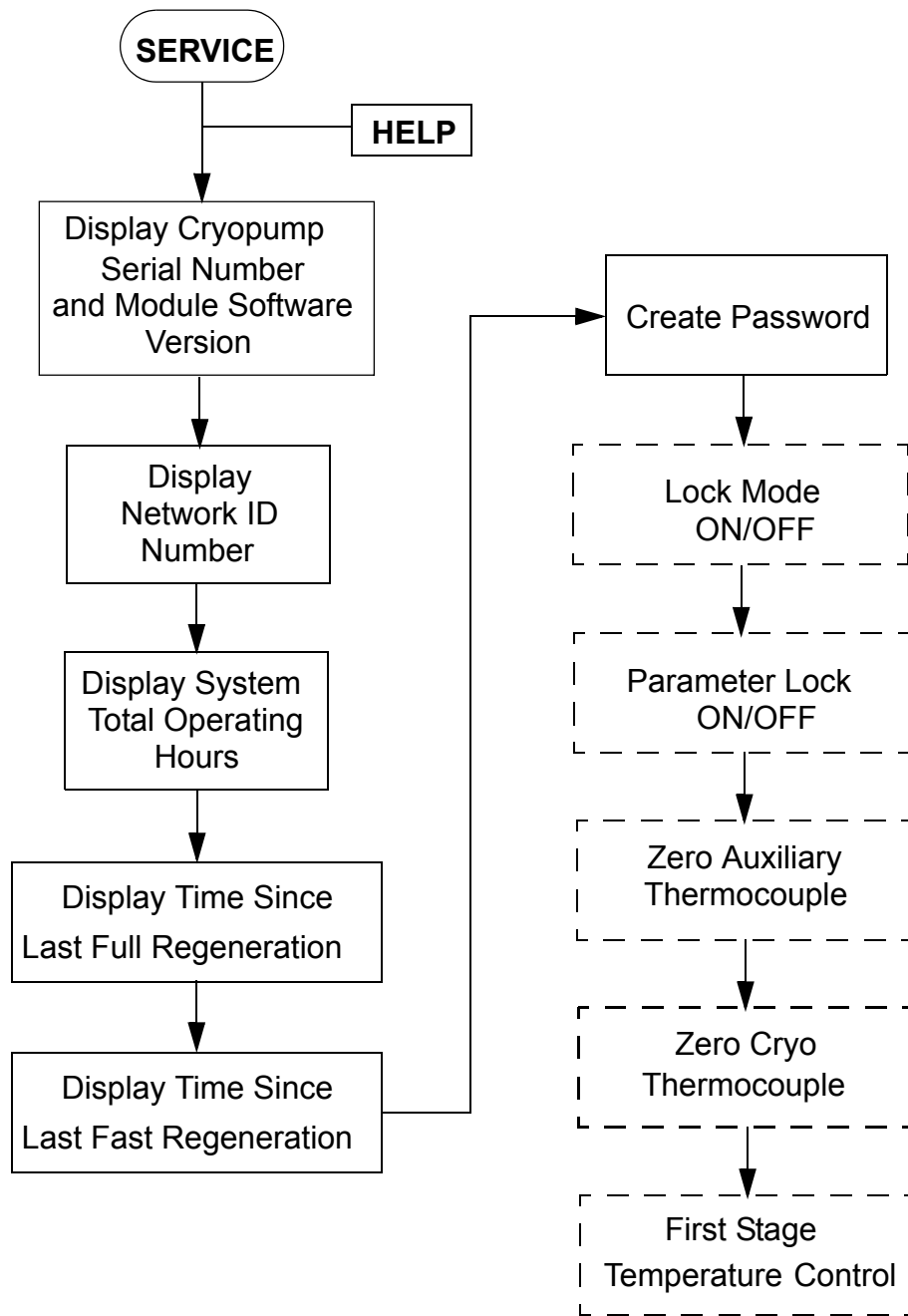

Figure 3-26: On-Board Cryopump Fast Regeneration Cycle Example (continued)

SERVICE Function

The On-Board FastRegen Control Module SERVICE function allows you to access cryopump identification information, elapsed pump times, and establish password protection as shown in Figure 3-27. The default and range of SERVICE function parameters are listed in Table 3-2. An explanation of each parameter is provided on the following pages.



Can only be completed if a password is created.

Figure 3-27: SERVICE Function Flowchart

Table 3-2: SERVICE Function Parameters

SERVICE Parameter	Default Value	Range of Values
Serial Number/Software Version	-	-
Net ID	0	0 - 9
Elapsed Pump Time	-	Hours
Time Since Last Full Regeneration	-	Hours
Time Since Last Fast Regeneration	-	Hours
Password	0	0 - 32,767
Lock Mode	OFF	1 (ON)/ 0 (OFF)
Parameter Lock	OFF	1 (ON)/ 0 (OFF)
Zero Auxiliary Thermocouple	-	-
Zero Cryopump Thermocouple	-	-
First Stage Temperature	ON	1 (ON)/ 0 (OFF)

Serial Number and Software Version

The first parameter of the SERVICE function allows you to display the On-Board Cryopump serial number (SN information) and current module software version (P information) as shown in Figure 3-28.

The serial number is used to identify the cryopump. The software version number identifies the software which is running in the On-Board FastRegen Control Module.

***NOTE:** Press the > key to display the entire software version number.*

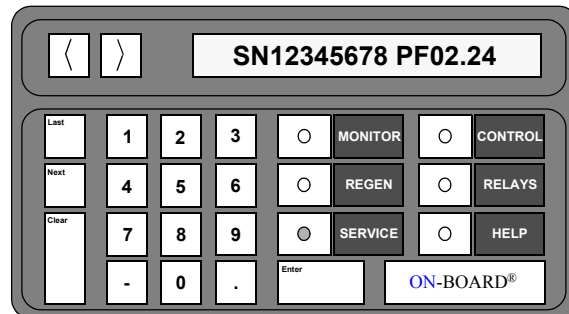

Figure 3-28: Serial Number and Software Version Display

Network Identification Number

The second parameter of the SERVICE function indicates the position of the network rotary switch on the On-Board FastRegen Control Module. The position of the rotary switch identifies the network address of the cryopump. The Net Identification screen, shown in Figure 3-29, indicates that the network rotary switch on the On-Board FastRegen Control Module is set to position 3.

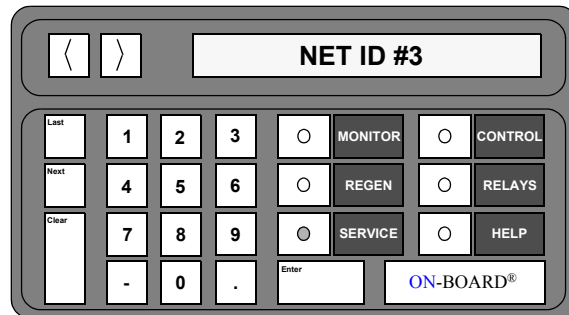

Figure 3-29: Network Identification Number Screen

Elapsed Pump Time

The third parameter of the SERVICE function allows you to display the total number of On-Board Cryopump operating hours as shown in Figure 3-30.

NOTE: *The clock cannot be reset.*

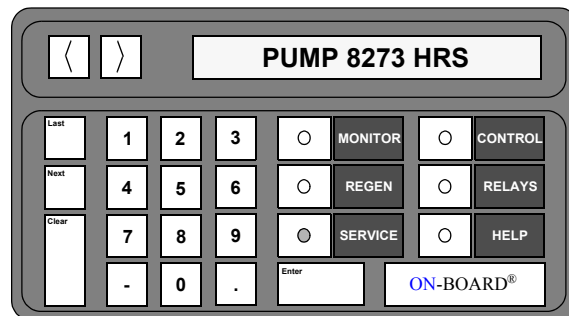

Figure 3-30: Elapsed Pump Time Display

Time Since Last Full Regeneration

The fourth parameter of the SERVICE function allows you to display the total number of hours since the last Full regeneration cycle was performed as shown in Figure 3-31. The clock is automatically reset to zero upon the completion of the last Full regeneration cycle.

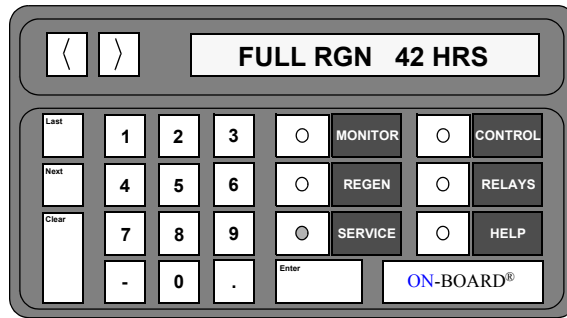

Figure 3-31: Time Since Last Full Regeneration Display

Time Since Last Fast Regeneration

The fifth parameter of the SERVICE function allows you to display the total number of hours since the last Fast regeneration cycle was performed as shown in Figure 3-32. The clock is automatically reset to zero upon the completion of the last Fast regeneration cycle.

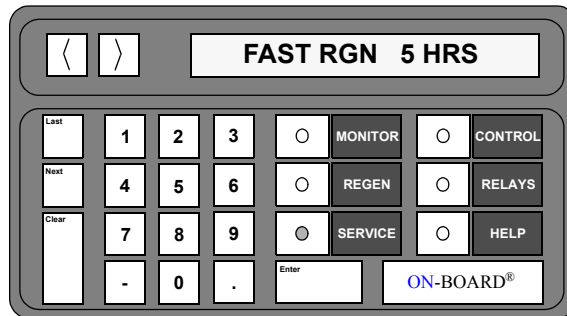

Figure 3-32: Time Since Last Fast Regeneration Display

Password

The sixth parameter of the SERVICE function allows you to create or display a password. A password allows a level of system security to prevent unauthorized users from accessing SERVICE functions. The password display screen is shown in Figure 3-33.

NOTE: Refer to **Appendix A** and contact the local customer support center if the password is forgotten. A master password can be used to clear the original password.

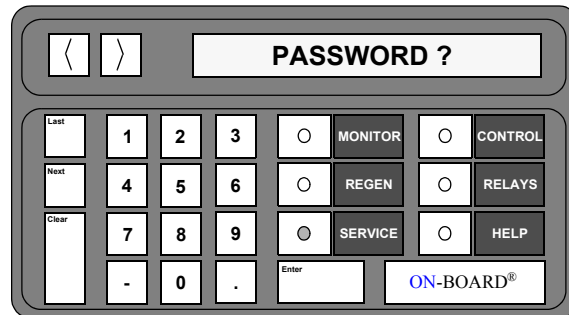

Figure 3-33: Password Screen Display

Lock Mode

The seventh parameter of the SERVICE function prevents an unauthorized user from accessing the REGEN, CONTROL, or RELAYS functions when lock mode is ON. A **LOCKED OUT** message is displayed when the REGEN, CONTROL, or RELAYS keys are pressed. The Lock Mode OFF screen is shown in Figure 3-34.

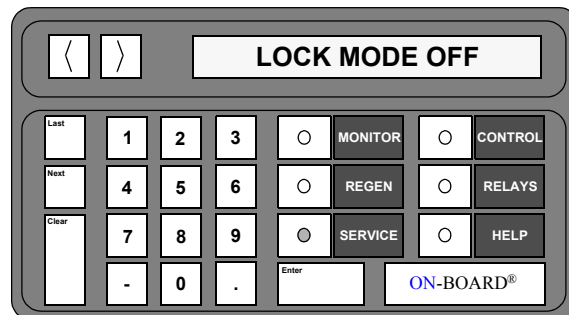

Figure 3-34: Lock Mode OFF Display

Parameter Lock

The eighth parameter of the SERVICE function prevents an unauthorized user from accessing all programmable REGEN parameters and relay setpoints. When an attempt is made to change a programmable setpoint with Parameter Lock ON, the *CHANGES LOCKED* message is displayed as shown in Figure 3-35. All parameters which can be turned ON or OFF, including Regeneration, are still accessible with Parameter Lock turned ON.

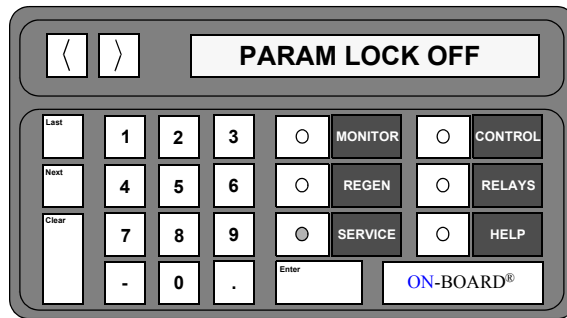

Figure 3-35: Parameter Lock ON Display

Zero Auxiliary Thermocouple

The ninth parameter of the SERVICE function, as shown in Figure 3-36, resets the auxiliary thermocouple gauge to zero. The auxiliary thermocouple gauge reading is displayed until the gauge is set to zero.

NOTE: The auxiliary thermocouple gauge must be turned ON and under a vacuum of less than 10^{-4} torr (less than 1 micron) before this parameter can be used. Any attempt to zero the gauge at a pressure above 30 microns, or when the gauge is turned OFF, results in a calibration failure.

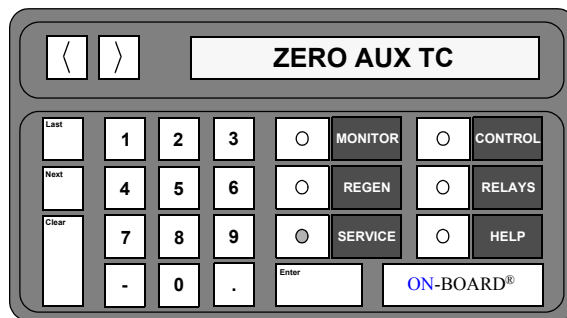

Figure 3-36: Zero Auxiliary Thermocouple Display

Zero Cryo Thermocouple

The tenth parameter of the SERVICE function, as shown in Figure 3-37, resets the cryo thermocouple gauge to zero. The cryo thermocouple gauge reading is displayed until the gauge is set to zero.

NOTE: The cryo thermocouple gauge must be turned ON and under a vacuum of less than 10^{-4} torr (less than 1 micron) before this parameter can be used. Any attempt to zero the gauge at a pressure above 30 microns, or when the gauge is turned OFF, results in a calibration failure.

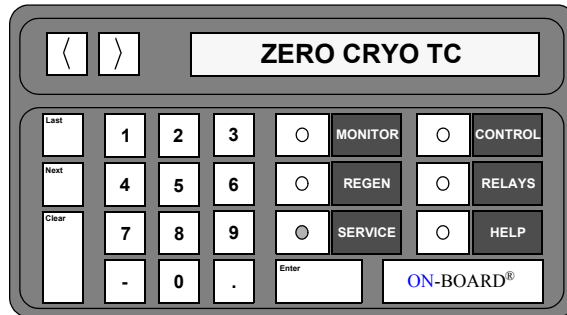

Figure 3-37: Zero Cryo Thermocouple Gauge Display

First Stage Temperature Control

The eleventh and final parameter of the SERVICE function allows the first stage temperature control of the cryopump to be turned ON or OFF. The first stage temperature setting is displayed as shown in Figure 3-38.

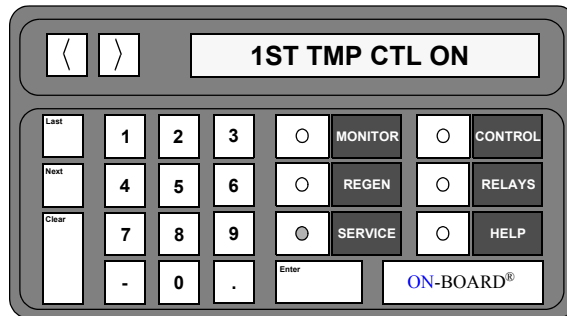

Figure 3-38: First Stage Temperature Control Display

SERVICE Function Operation

Use the following procedures to operate the SERVICE function parameters of the On-Board FastRegen Control Module.

Serial Number and Software Version

1. Press the **SERVICE** key on the keypad/display. The serial number and software version information are displayed.
2. Press the **MONITOR** key. The On-Board microprocessor will monitor system operation.

Net Identification

1. Press the **SERVICE** key on the keypad/display. The serial number and software version information are displayed.
2. Press the **Next** key. The *Net ID* number is displayed.
3. Press the **MONITOR** key. The On-Board microprocessor will monitor system operation.

Elapsed Pump Time

1. Press the **SERVICE** key on the keypad/display. The serial number and software version information are displayed.
2. Press the **Next** key until the *Pump Hours* are displayed.
3. Press the **MONITOR** key. The On-Board microprocessor will monitor system operation.

Time Since Last Full Regeneration

1. Press the **SERVICE** key on the keypad/display. The serial number and software version information are displayed.
2. Press the **Next** key until the *Full RGN Hours* are displayed.
3. Press the **MONITOR** key. The On-Board microprocessor will monitor system operation.

Time Since Last Fast Regeneration

1. Press the **SERVICE** key on the keypad/display. The serial number and software version information are displayed.
2. Press the **Next** key until the *Fast RGN Hours* are displayed.
3. Press the **MONITOR** key. The On-Board microprocessor will monitor system operation.

Password

1. Press the **SERVICE** key on the keypad/display. The serial number and software version information are displayed.
2. Press the **Next** key until the *Password* prompt is displayed.
3. Press the **Enter** key. *0 = Password* is displayed.
4. Press the **Enter** key again. The current value is underlined and ready to accept a new value.
5. Press the numeral keys for the desired password. The range of values is 0 - 32767.
6. Press the **Enter** button.
7. Press the **MONITOR** key. The On-Board microprocessor will monitor system operation.

***NOTE:** Refer to **Appendix A** and contact the local customer support center if the password is forgotten. A master password can be used to access the original password.*

Lock Mode

***NOTE:** The Lock Mode parameter cannot be accessed unless a password has been entered.*

1. Press the **SERVICE** key on the keypad/display. The serial number and software version information are displayed.
2. Press the **Next** key until the *Password?* prompt is displayed.
3. Enter the password and press **Enter**.
4. Press the **Next** key until the current status of *Lock Mode* is displayed.
5. Press **1** to enable or press **0** to disable lock mode.
6. Press the **MONITOR** key. The On-Board microprocessor will monitor system operation.

Parameter Lock

***NOTE:** The Parameter Lock parameter cannot be accessed unless a password has been entered.*

1. Press the **SERVICE** key on the keypad/display. The serial number and software version information are displayed.
2. Press the **Next** key until the *Password?* prompt is displayed.
3. Enter the password and press **Enter**.
4. Press the **Next** key until the current status of *Param Lock* is displayed.
5. Press **1** to enable or press **0** to disable parameter lock mode.
6. Press the **MONITOR** key. The On-Board microprocessor will monitor system operation.

Zero Auxiliary Thermocouple

***NOTE:** The Zero Auxiliary Thermocouple parameter cannot be accessed unless a password has been entered.*

***NOTE:** The auxiliary thermocouple gauge must be turned ON and under a vacuum of less than 10^{-4} torr (less than 1 micron) before this procedure can be used. Any attempt to zero the gauge at a pressure above 30 microns, or when the gauge is turned OFF, results in a calibration failure.*

1. Press the **SERVICE** key on the keypad/display. The serial number and software version information are displayed.
2. Press the **Next** key until the *Password?* prompt is displayed.
3. Enter the password and press **Enter**.
4. Press the **Next** key until *Zero AUX TC* is displayed.
5. Press the **Enter** key. The auxiliary thermocouple pressure is displayed until zero is reached. After approximately 1 minute, *Complete* will be displayed.
6. Press the **MONITOR** key. The On-Board microprocessor will monitor system operation.

Zero Cryo Thermocouple

***NOTE:** The Zero Cryo Thermocouple parameter cannot be accessed unless a password has been entered.*

***NOTE:** The cryo thermocouple gauge must be turned ON and under a vacuum of less than 10^{-4} torr (less than 1 micron) before this procedure can be used. Any attempt to zero the gauge at a pressure above 30 microns, or when the gauge is turned OFF, results in a calibration failure.*

1. Press the **SERVICE** key on the keypad/display. The serial number and software version information are displayed.
2. Press the **Next** key until the *Password?* prompt is displayed.
3. Enter the password and press **Enter**.
4. Press the **Next** key until *Zero Cryo TC* is displayed.
5. Press the **Enter** key. The cryo thermocouple pressure is displayed until zero is reached. After approximately 1 minute, *Complete* will be displayed.
6. Press the **MONITOR** key. The On-Board microprocessor will monitor system operation.

First Stage Temperature Control

***NOTE:** The First Stage Temperature Control parameter cannot be accessed unless a password has been entered.*

1. Press the **SERVICE** key on the keypad/display. The serial number and software version information are displayed.
2. Press the **Next** key until the *Password?* prompt is displayed.
3. Enter the password and press **Enter**.
4. Press the **Next** key until *1ST TMP CTL* is displayed.
5. Press the **Enter** key. Press **1** to turn on the first stage temperature control. Press **0** to turn it OFF.
6. Press the **Enter** button.
7. Press the **MONITOR** key. The On-Board microprocessor will monitor system operation.

CONTROL Function

The CONTROL function within the On-Board FastRegen Control Module allows you to turn the On-Board Cryopump, plus selected gauges, valves, and relays ON or OFF. These functions can be used during manual regeneration and system diagnosis.

The CONTROL function parameters are shown in Figure 3-39 and described on the following pages. The default setting and range of CONTROL parameters are provided in Table 3-3.

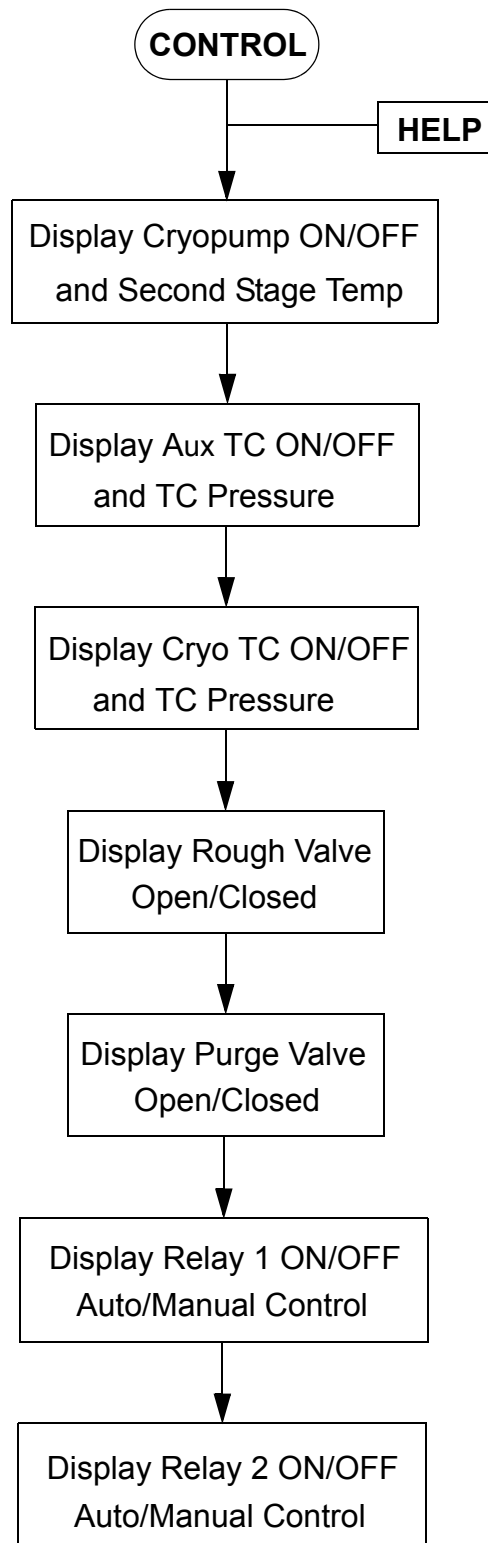

Figure 3-39: CONTROL Function Flowchart

Table 3-3: CONTROL Function Parameters

CONTROL Parameter	Default Value	Range of Values
Cryopump ON/OFF	OFF	ON/OFF
Aux TC ON/OFF	OFF	ON/OFF
Cryo TC ON/OFF	OFF	ON/OFF
Rough Valve Open/Closed	Closed	Open/Closed
Purge Valve Open/Closed	Closed	Open/Closed
Relay 1 ON/OFF and Auto/Manual Control	OFF, Manual	ON/OFF (Auto/Manual)
Relay 2 ON/OFF and Auto/Manual Control	OFF, Manual	ON/OFF (Auto/Manual)

Cryopump ON/OFF and Second Stage Temperature

The first parameter of the CONTROL function allows you to turn the cryopump motor ON or OFF. The keypad/display shows the ON/OFF status and second stage temperature as shown in Figure 3-40.

***NOTE:** Check the power connections, fuses, and switches on the On-Board compressor if the NO CRYO POWER1 or NO CRYO POWER2 message appears in the display.*

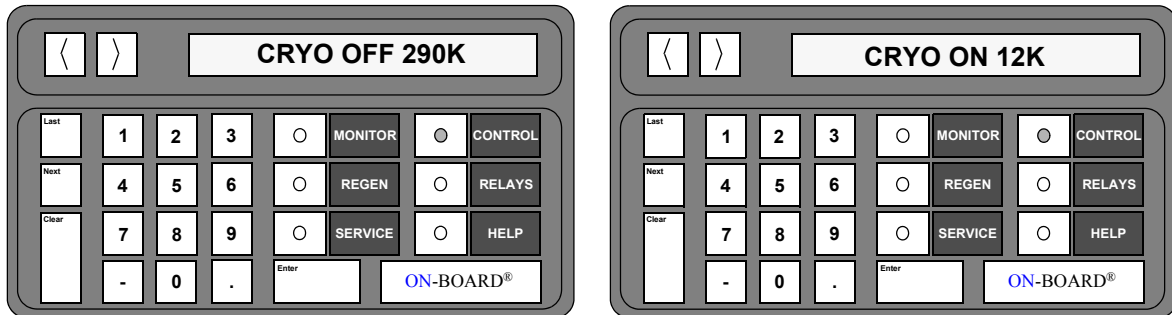

Figure 3-40: Cryopump ON/OFF and Second Stage Temperature Display

Aux TC ON/OFF and TC Pressure

The second parameter of the CONTROL function allows you to turn the auxiliary thermocouple gauge ON or OFF. The keypad/display shows the ON/OFF status of the thermocouple pressure as shown in Figure 3-41.

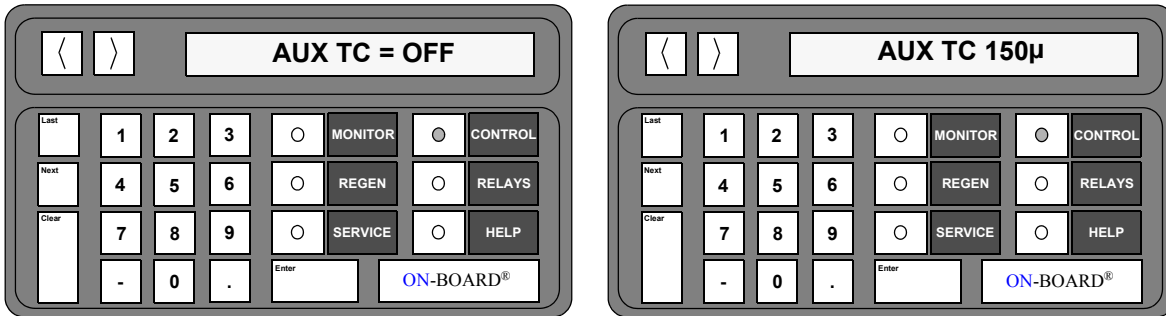

Figure 3-41: Aux TC ON/OFF and TC Pressure Display

Cryo TC ON/OFF and TC Pressure

The third parameter of the CONTROL function allows you to turn the auxiliary thermocouple gauge ON or OFF. The keypad/display shows the ON/OFF status of the thermocouple pressure as shown in Figure 3-42.

NOTE: The TC INTERLOCK message appears and the Cryo TC Gauge will not turn ON when the second stage temperature is above 20K. The CRYO TC Gauge turns OFF automatically if the temperature goes above 20K. If the temperature is above 20K, the Cryo TC Gauge can only be turned ON if the purge and roughing valves have been opened for regeneration.

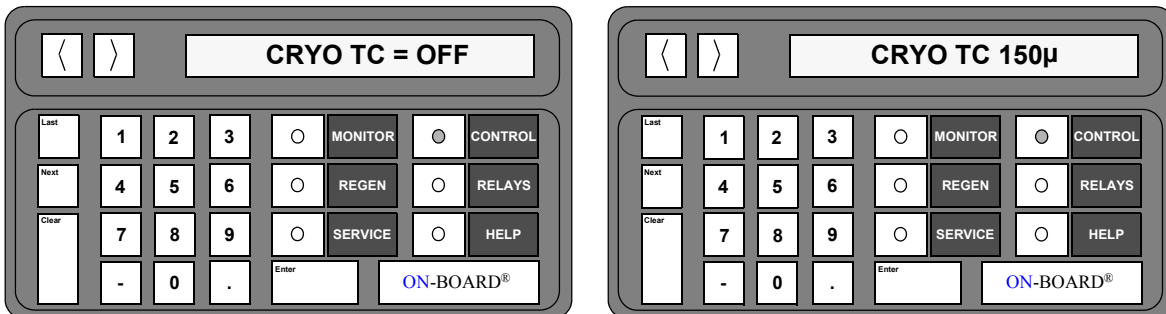

Figure 3-42: Cryo TC ON/OFF and TC Pressure Display

Rough Valve Open/Closed

CAUTION

Opening the rough valve when the On-Board Cryopump is turned ON may cause oil from the roughing pump to backstream into the vacuum chamber and contaminate the cryopump arrays. A message is displayed on the keypad/display warning you about this potential problem.

The fourth parameter of the CONTROL function allows you to open or close the rough valve as shown in Figure 3-43.

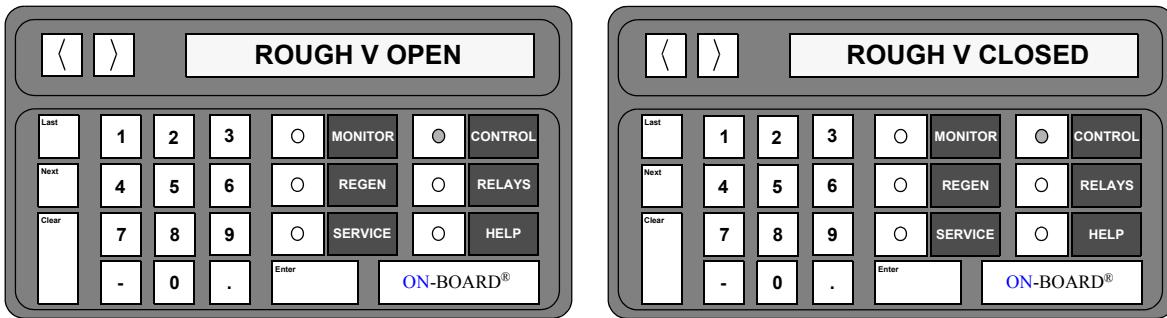

Figure 3-43: Rough Valve Open/Closed Display

Purge Valve Open/Closed

CAUTION

Opening the purge valve when the On-Board Cryopump is turned ON may contaminate the cryopump arrays. A message is displayed on the keypad/display warning you about this potential problem.

The fifth parameter of the CONTROL function allows you to open or close the purge valve as shown in Figure 3-44.

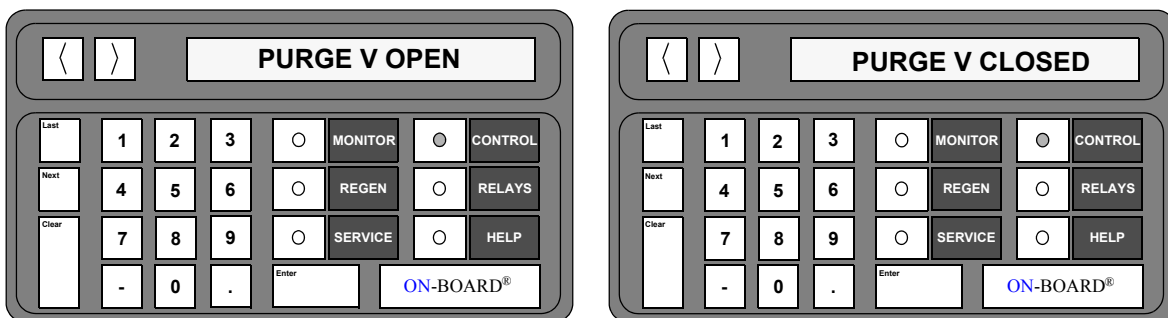

Figure 3-44: Purge Valve Open/Closed Display

Relay 1 ON/OFF and Auto/Manual Control

The sixth parameter of the CONTROL function allows you to turn relay 1 ON or OFF and select between automatic or manual control as shown in Figure 3-45. Manual control is typically used during system diagnosis when manual activation of relay 1 is required.

Automatic control is used to automatically turn relay 1 ON or OFF depending upon user specified relay programming. You cannot turn relay 1 ON or OFF when it is in automatic control.

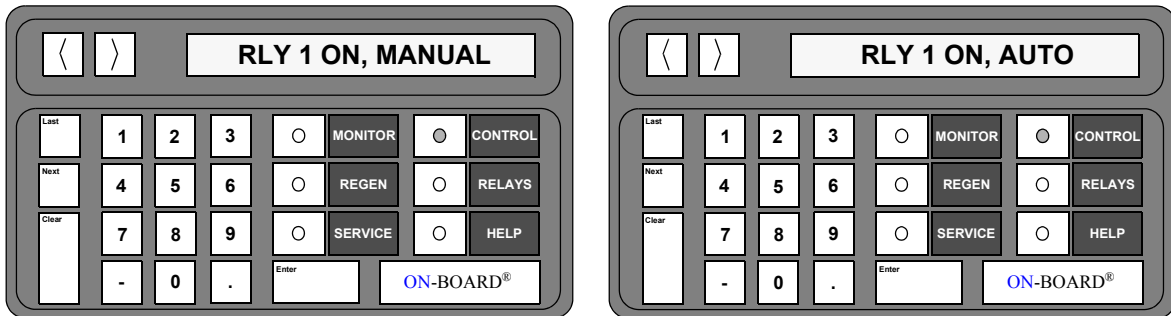

Figure 3-45: Relay 1 ON/OFF and Auto/Manual Control Display

Relay 2 ON/OFF and Auto/Manual Control

The seventh parameter of the CONTROL function allows you to turn relay 2 ON or OFF and select between automatic or manual control as shown in Figure 3-46. Manual control is typically used during system diagnosis when manual activation of relay 2 is required.

Automatic control is used to automatically turn relay 2 ON or OFF depending upon user specified relay programming. You cannot turn relay 2 ON or OFF when it is in automatic control.

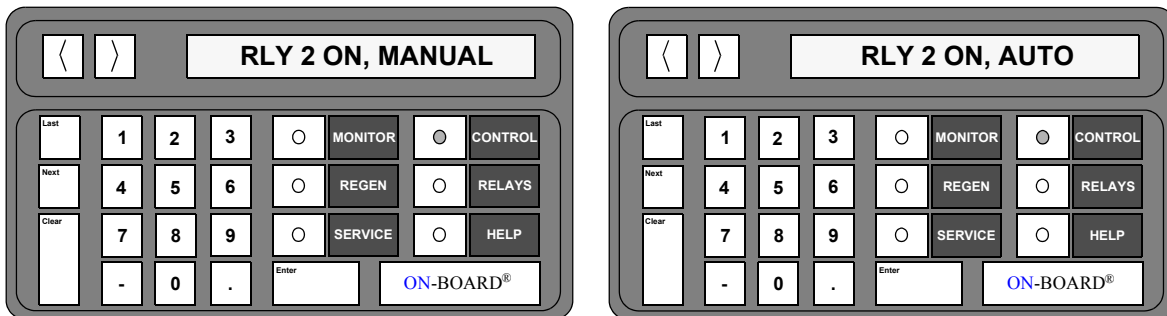

Figure 3-46: Relay 2 ON/OFF and Auto/Manual Control Display

CONTROL Function Operation

Use the following procedures to operate the CONTROL parameters of the On-Board FastRegen Control Module.

Cryopump ON/OFF and Second Stage Temperature

1. Press the **CONTROL** key on the keypad/display. The ON/OFF status and the second stage temperature of the cryopump are displayed.

***NOTE:** Refer to **Appendix A** and contact the local CTI-CRYOGENICS customer support center if the letters **SHO** or **OPN** are displayed.*

2. Press **1** to turn the cryopump ON, or press **0** to turn the cryopump OFF.
3. Press the **MONITOR** key. The On-Board microprocessor will monitor system operation.

Aux TC ON/OFF and TC Pressure

1. Press the **CONTROL** key on the keypad/display. The ON/OFF status and the second stage temperature of the cryopump are displayed.
2. Press the **Next** key. The *Aux TC* pressure is displayed in microns.
3. Press **1** to turn the Aux TC ON, or press **0** to turn the Aux TC OFF.
4. Press the **MONITOR** key. The On-Board microprocessor will monitor system operation.

Cryo TC ON/OFF and TC Pressure

1. Press the **CONTROL** key on the keypad/display. The ON/OFF status and the second stage temperature of the cryopump are displayed.
2. Press the **Next** key until the *Cryo TC* pressure is displayed in microns.
3. Press **1** to turn the CRYO TC ON, or press **0** to turn the Cryo TC OFF.
4. Press the **MONITOR** key. The On-Board microprocessor will monitor system operation.

Rough Valve Open/Closed

1. Press the **CONTROL** key on the keypad/display. The ON/OFF status and the second stage temperature of the cryopump are displayed.
2. Press the **Next** key until the current rough valve status is displayed.
3. Press **1** to open the rough valve, or press **0** to close the rough valve.
4. Press the **MONITOR** key. The On-Board microprocessor will monitor system operation.

Purge Valve Open/Closed

1. Press the **CONTROL** key on the keypad/display. The ON/OFF status and the second stage temperature of the cryopump are displayed.
2. Press the **Next** key until the current purge valve status is displayed.
3. Press **1** to open the purge valve, or press **0** to close the purge valve.
4. Press the **MONITOR** key. The On-Board microprocessor will monitor system operation.

Relay 1 ON/OFF and Auto/Manual Control

1. Press the **CONTROL** key on the keypad/display. The ON/OFF status and the second stage temperature of the cryopump are displayed.
2. Press the **Next** key until the current status and mode for relay 1 are displayed.
3. Press one of the following number keys for the desired relay activity:
 - 1** to turn relay 1 ON
 - 0** to turn relay 1 OFF
 - 7** to turn automatic mode ON
 - 9** to turn manual mode ON
4. Press the **MONITOR** key. The On-Board microprocessor will monitor system operation.

Relay 2 ON/OFF and Auto/Manual Control

1. Press the **CONTROL** key on the keypad/display. The ON/OFF status and the second stage temperature of the cryopump are displayed.
2. Press the **Next** key until the current status and mode for relay 2 are displayed.
3. Press one of the following number keys for the desired relay activity:
 - 1** to turn relay 2 ON
 - 0** to turn relay 2 OFF
 - 7** to turn automatic mode ON
 - 9** to turn manual mode ON
4. Press the **MONITOR** key. The On-Board microprocessor will monitor system operation.

RELAYS Function

The RELAYS function within the On-Board FastRegen Control Module allows you to program the setpoint relays to open or close when a vacuum system function occurs.

***NOTE:** Relay activation/deactivation is dependent upon the manner in which the relays are wired, normally open or normally closed.*

The RELAYS function parameters are shown in Figure 3-47. Relay parameters and their ranges are provided in Table 3-4 and are described on the following pages.

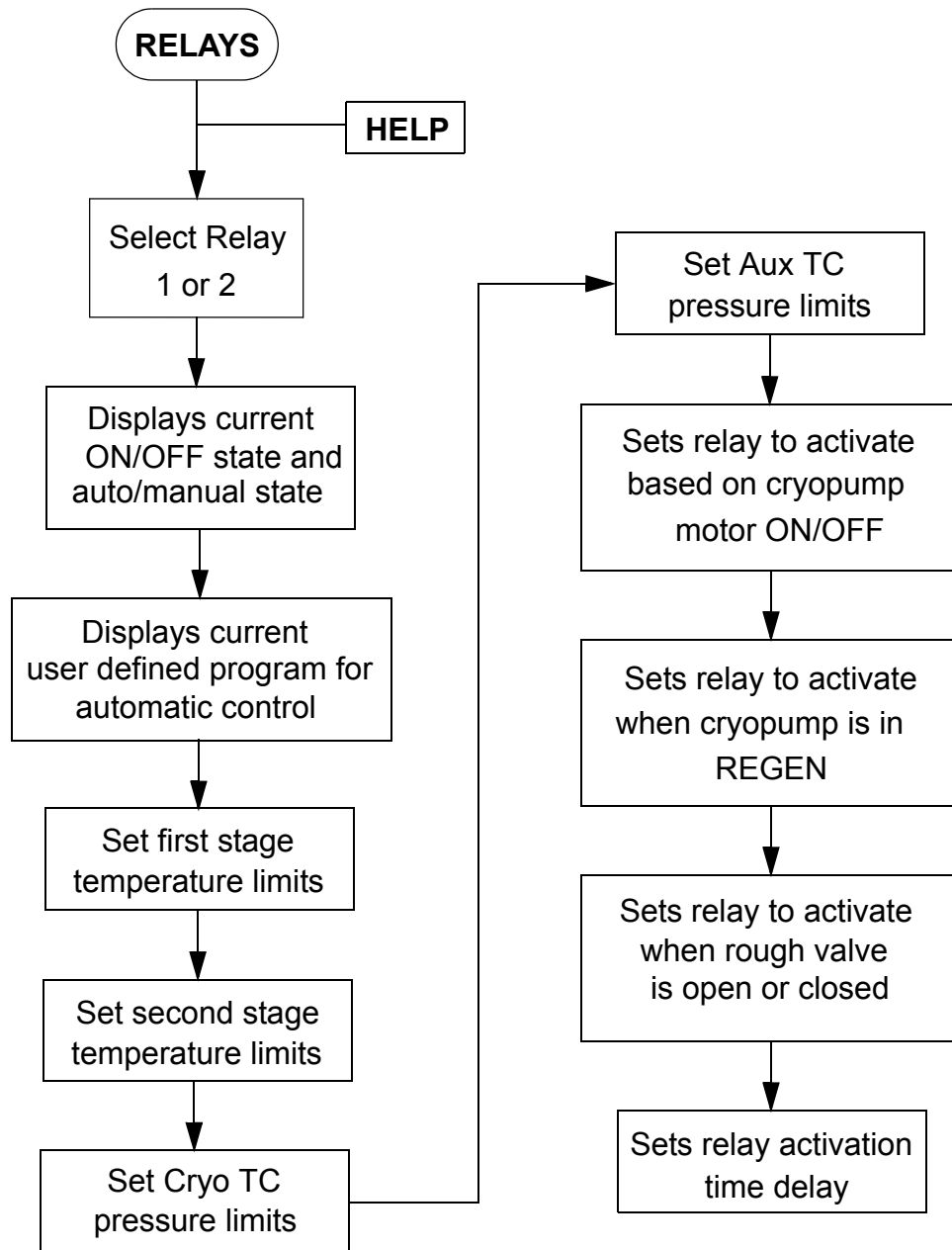

Figure 3-47: RELAYS Function Flowchart

Table 3-4: RELAYS Function Parameters

RELAYS Parameter	Range of Values
Relay 1 or 2	1 - 2
Relay ON/OFF, Auto/Manual	ON/OFF Auto/Manual
First Stage Temperature	30K - 310K
Second Stage Temperature	10K - 310K
Cryo TC Pressure	1 - 999 microns
Aux TC Pressure	1 - 999 microns
Cryopump	ON/OFF
REGEN Track	ON/OFF
Rough Valve	ON/OFF
Time Delay	0 - 99 seconds

Select Relay 1 or 2

The first parameter of the RELAYS function allows you to select setpoint relay 1 or 2 to be programmed as shown in Figure 3-48.

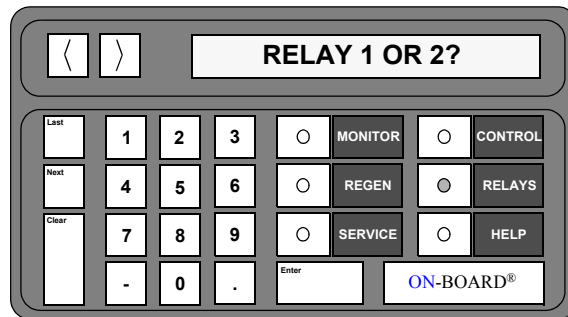

Figure 3-48: Select Relay 1 or 2 Display

Current State of Relay ON/OFF, Auto/Manual

The second parameter of the RELAYS function allows you to determine whether the relay is ON or OFF and in automatic or manual mode shown in Figure 3-49. If in automatic mode, the relay is programmed to activate (ON/OFF) based upon a programmed function *as listed*.

NOTE: Relay activation is controlled in the CONTROL function if in manual mode.

Automatic control is used to turn the setpoint relay ON or OFF based upon user specified programming. You cannot manually turn the setpoint relay ON or OFF when in automatic control. Manual control is typically used during system diagnosis when manual activation of a setpoint relay is required.

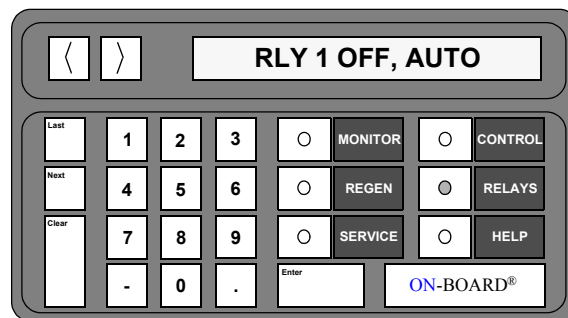

Figure 3-49: Current State of Relay ON/OFF, Auto/Manual

Current Program for Automatic Control

The third parameter of the RELAYS function displays the current user defined program which was selected for automatic control of the setpoint relays. The message shown in Figure 3-50 for example, means that the relay is activated based upon the cryopump motor being turned ON or OFF.

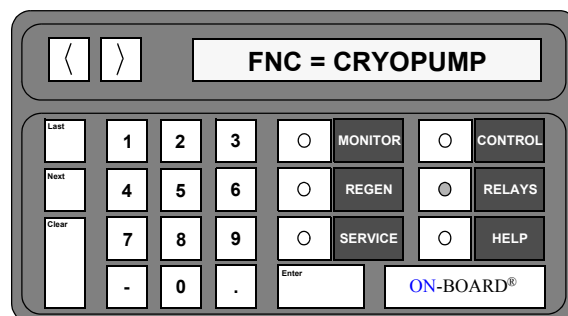

Figure 3-50: Current Program for Automatic Control Display

First Stage Temperature Limits

The fourth parameter of the RELAYS function allows you to establish the upper and lower first stage temperature limits of the cryopump as shown in Figure 3-51. The upper limit is designated as *UL* and the lower limit is designated as *LL*.

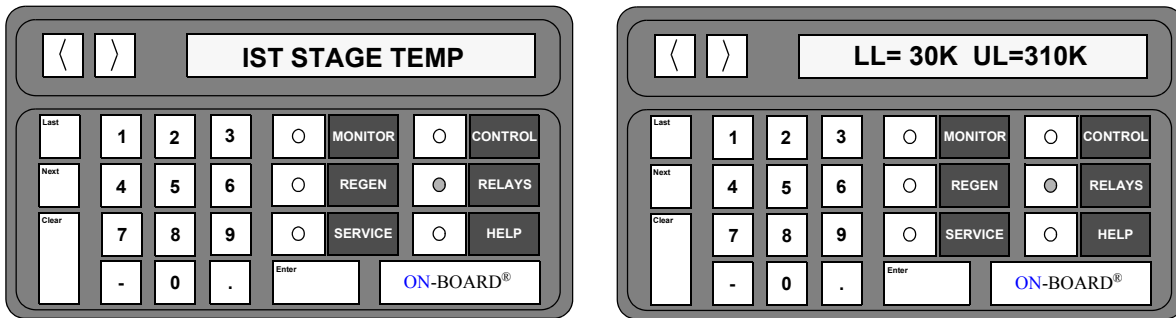

Figure 3-51: First Stage Temperature Limits Display

Second Stage Temperature Limits

The fifth parameter of the RELAYS function allows you to establish the upper and lower second stage temperature limits of the cryopump as shown in Figure 3-52. The upper limit is designated as *UL* and the lower limit is designated as *LL*.

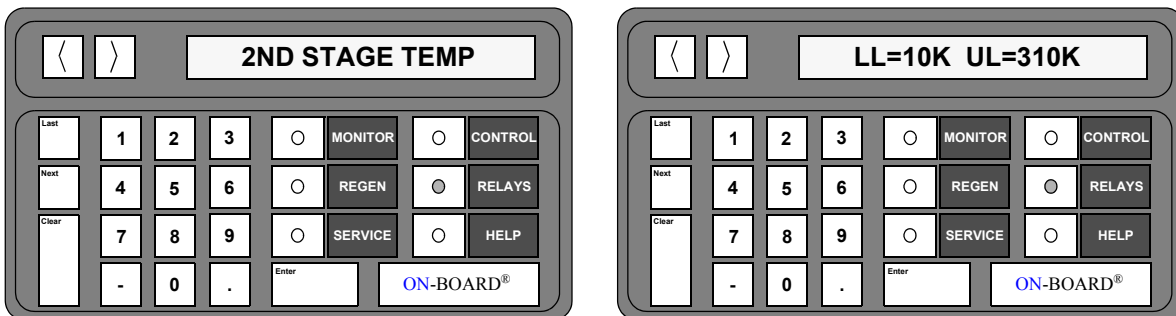

Figure 3-52: Second Stage Temperature Limits Display

Cryo Thermocouple Pressure Limits

The sixth parameter of the RELAYS function allows you to establish the upper and lower pressure limits of the cryopump thermocouple gauge as shown in Figure 3-53.

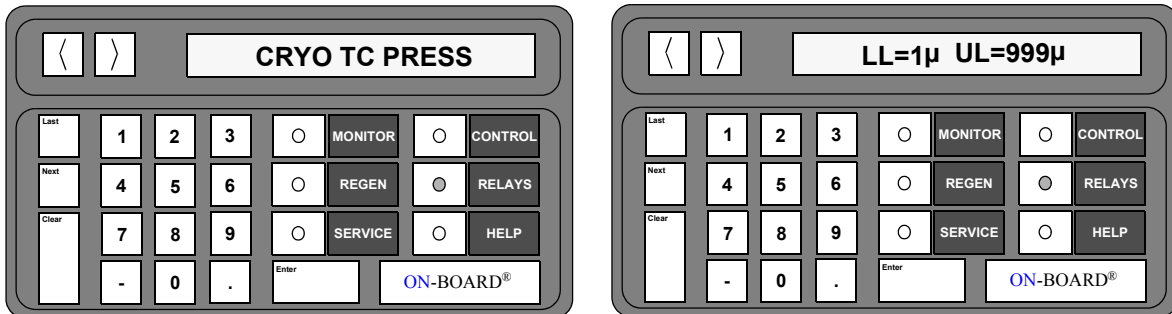

Figure 3-53: Cryo Thermocouple Pressure Limits Display

Auxiliary Thermocouple Pressure Limits

The seventh parameter of the RELAYS function allows you to establish the upper and lower pressure limits of the cryopump auxiliary thermocouple gauge as shown in Figure 3-54.

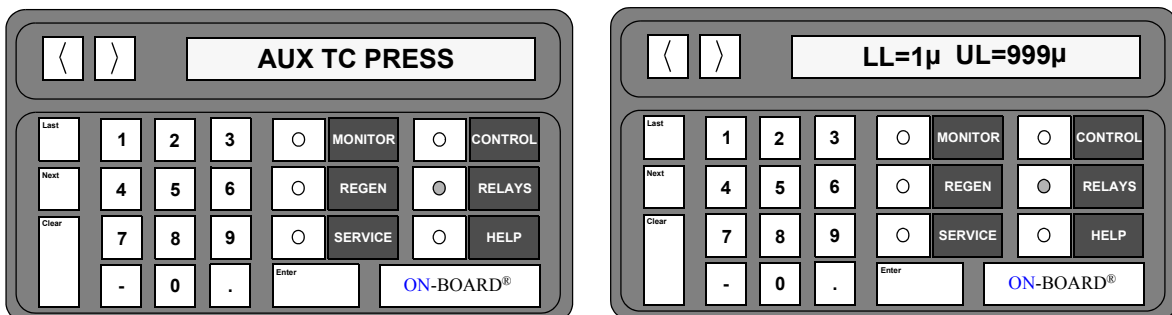

Figure 3-54: Auxiliary Thermocouple Pressure Limits Display

Cryopump

The eighth parameter of the RELAYS function allows you to program the setpoint relay to activate when the cryopump motor is turned ON and deactivate when the motor is turned OFF as shown in Figure 3-55.

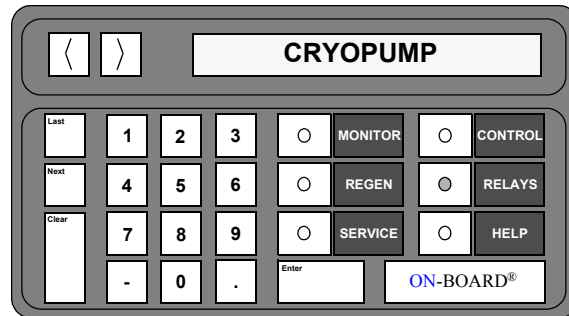

Figure 3-55: Cryopump Display

Regeneration

The ninth parameter of the RELAYS function allows you to program the setpoint relay to activate when the cryopump is in regeneration mode as shown in Figure 3-56.

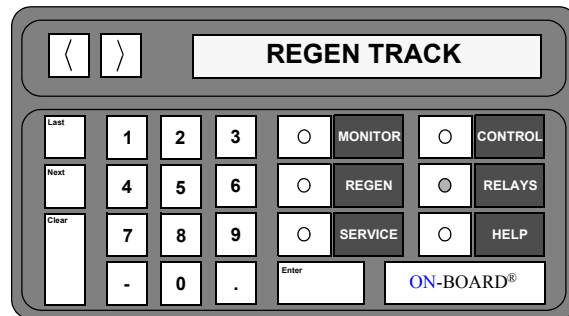

Figure 3-56: Regeneration Display

Roughing Valve

The tenth parameter of the RELAYS function allows you to program the setpoint relay to activate when the rough valve is opened and deactivate when the rough valve is closed as shown in Figure 3-57.

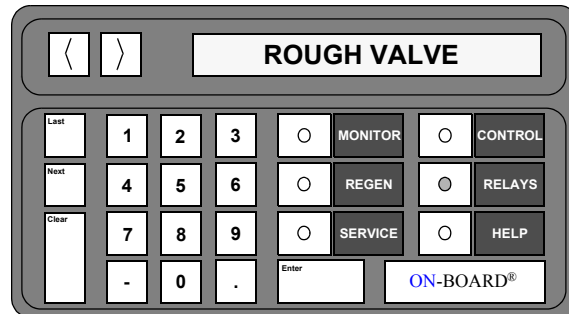

Figure 3-57: Roughing Valve Display

Delay Activation of Relay

The eleventh parameter of the RELAYS function allows you to establish a delay time during which your selected relay waits before operating as shown in Figure 3-58. This parameter will delay both activation and deactivation of the relays.

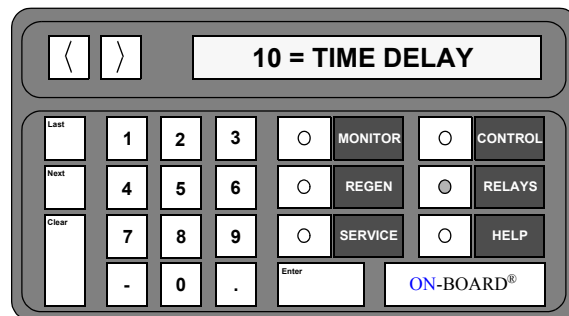

Figure 3-58: Delay Activation of Relay Display

RELAYS Function Operation

Only one Relay parameter can be in control of the relay at anytime. Once a Relay parameter has been programmed, your selected relay will be placed in automatic mode as indicated by the *FNC = CRYOPUMP* message. FNC is an abbreviation for *Function* and the message indicates the relay will be activated when the cryopump motor is turned ON. The previously programmed relay parameter (if one exists) will be cancelled. The *FNC = MANUAL OFF* message indicates that none of the Relay parameters have been programmed.

Use the following procedures to program the Relay parameters of the On-Board FastRegen Control Module.

NOTE: *Relay activation/deactivation is dependent upon the manner in which the relays are wired, normally open or normally closed.*

Programming First Stage Temperature Limits

This procedure programs relay 1 or 2 to activate/deactivate when either of the cryopump first stage temperature limits are reached.

1. Press the **RELAYS** key on the keypad/display.
2. Press **1** or **2** depending upon which relay is being selected. The selected relay number along with the ON/OFF and Auto/Manual status are displayed.
3. Press the **Next** key until the *1st Stage Temperature* is displayed.
4. Press the **Enter** key. The cursor is placed under the current lower limit (LL) value.

NOTE: *If a number which is not in the proper range is entered, LL-??K or UL-??K will be displayed. Press the Clear button to continue.*

5. Using the keypad, enter the new lower limit value.
6. Press the **Enter** key. The cursor is placed under the current upper limit (UL) value.
7. Using the keypad, enter the new upper limit value.
8. Press the **Enter** key. The limit values are programmed.
9. Press the **MONITOR** key. The On-Board microprocessor will monitor system operation.

Programming Second Stage Temperature Limits

This procedure programs relay 1 or 2 to activate/deactivate when either of the cryopump second stage temperature limits are reached.

1. Press the **RELAYS** key on the keypad/display.
2. Press **1** or **2** depending upon which relay is being selected. The selected relay number along with the ON/OFF and Auto/Manual status are displayed.
3. Press the **Next** key until the *2nd Stage Temperature* is displayed.
4. Press the **Enter** key. The cursor is placed under the current lower limit (LL) value.

***NOTE:** If a number which is not in the proper range is entered, LL-??K or UL-??K will be displayed. Press the Clear button to continue.*

5. Using the keypad, enter the new lower limit value.
6. Press the **Enter** key. The cursor is placed under the current upper limit (UL) value.
7. Using the keypad, enter the new upper limit value.
8. Press the **Enter** key. The limit values are programmed.
9. Press the **MONITOR** key. The On-Board microprocessor will monitor system operation.

Programming Cryo Thermocouple Pressure Limits

This procedure programs relay 1 or 2 to activate/deactivate when either of the cryopump thermocouple pressure limits are reached.

1. Press the **RELAYS** key on the keypad/display.
2. Press **1** or **2** depending upon which relay is being selected. The selected relay number along with the ON/OFF and Auto/Manual status are displayed.
3. Press the **Next** key until *Cryo TC Press.* appears in the display.
4. Press the **Enter** key. The cursor is placed under the current lower limit (LL) value.

***NOTE:** If a number which is not in the proper range is entered, LL-??μ or UL-??μ will be displayed. Press the Clear button to continue.*

5. Using the keypad, enter the new lower limit value.
6. Press the **Enter** key. The cursor is placed under the current upper limit (UL) value.

7. Using the keypad, enter the new upper limit value.
8. Press the **Enter** key. The limit values are programmed.
9. Press the **MONITOR** key. The On-Board microprocessor will monitor system operation.

Programming Auxiliary Thermocouple Pressure Limits

This procedure programs relay 1 or 2 to activate/deactivate when either of the auxiliary thermocouple pressure limits are reached.

1. Press the **RELAYS** key on the keypad/display.
2. Press **1** or **2** depending upon which relay is being selected. The selected relay number along with the ON/OFF and Auto/Manual status are displayed.
3. Press the **Next** key until *AUX TC* appears in the display.
4. Press the **Enter** key. The cursor is placed under the current lower limit (LL) value.

***NOTE:** If a number which is not in the proper range is entered, LL-??? μ or UL-??? μ will be displayed. Press the Clear button to continue.*

5. Using the keypad, enter the new lower limit value.
6. Press the **Enter** key. The cursor is placed under the current upper limit (UL) value.
7. Using the keypad, enter the new upper limit value.
8. Press the **Enter** key. The limit values are programmed.
9. Press the **MONITOR** key. The On-Board microprocessor will monitor system operation.

Cryopump

This procedure programs relay 1 or 2 to activate/deactivate when the cryopump motor is turned ON or OFF.

1. Press the **RELAYS** key on the keypad/display.
2. Press **1** or **2** depending upon which relay is being selected. The selected relay number along with the ON/OFF and Auto/Manual status are displayed.
3. Press the **Next** key until *CRYOPUMP* appears in the display.
4. Press the **Enter** key. *FNC=CRYOPUMP* will be displayed. The relay is programmed.

5. Press the **MONITOR** key. The On-Board microprocessor will monitor system operation.

REGEN Track

This procedure programs relay 1 or 2 to activate/deactivate when the cryopump is in a regeneration cycle.

1. Press the **RELAYS** key on the keypad/display.
2. Press **1** or **2** depending upon which relay is being selected. The selected relay number along with the ON/OFF and Auto/Manual status are displayed.
3. Press the **Next** key until *Regen Track* appears in the display.
4. Press the **Enter** key. *FNC = Regen Track* will be displayed. The relay is programmed.
5. Press the **MONITOR** key. The On-Board microprocessor will monitor system operation.

Rough Valve

This procedure programs relay 1 or 2 to activate/deactivate when the rough valve opens/closes.

1. Press the **RELAYS** key on the keypad/display.
2. Press **1** or **2** depending upon which relay is being selected. The selected relay number and the ON/OFF and Auto/Manual status are displayed.
3. Press the **Next** button until *Rough Valve* appears in the display.
4. Press the **Enter** key. *FNC = Rough Valve* is displayed. The relay is programmed.
5. Press the **MONITOR** key. The On-Board microprocessor will monitor system operation.

Time Delay

This procedure programs relay 1 or 2 to delay activation/deactivation by a user determined amount of time.

1. Press the **RELAYS** key on the keypad/display.
2. Press **1** or **2** depending upon which relay is being selected. The selected relay number along with the ON/OFF and Auto/Manual status are displayed.
3. Press the **Next** key until the current *Time Delay* value appears in the display.
4. Press the **Enter** key.
5. Using the keypad, enter the desired amount of delay time (in seconds).
6. Press the **Enter** key. The new time delay value is programmed.
7. Press the **MONITOR** key. The On-Board microprocessor will monitor system operation.

FastRegen Control Module Software Function Parameters

Table 3-5 provides you with a complete listing of all FastRegen Control Module Software parameters. This table can be used as a quick reference to locate parameters within the MONITOR, REGEN, SERVICE, CONTROL, and RELAYS functions.

Table 3-5: On-Board FastRegen Control Module Software Parameters

MONITOR	REGEN	SERVICE	CONTROL	RELAYS
Cryopump ON/OFF Second Stage Temperature	REGEN ON/OFF	Serial Number/ Software Version	Cryopump ON/OFF Second Stage Temperature	Relay 1 or 2
First and Second Stage Temperature Aux TC Gauge Pressure	Delay Start	Net ID	Aux TC ON/OFF	Relay ON/OFF, Auto/Manual
First Stage Temperature	Delay Restart	Elapsed Pump Time	Cryo TC ON/OFF	Current Relay Program
Second Stage Temperature	Fast Rough Test	Time Since Last Full REGEN	Rough Valve Open/Closed	First Stage Temperature
Aux TC Gauge Pressure ON/OFF	Extended Purge	Time Since Last Fast Regeneration	Purge Valve Open/Closed	Second Stage Temperature
Cryo TC Gauge Pressure ON/OFF	Repurge	Password	Relay 1 ON/OFF and Auto/Manual Control	Cryo TC Pressure
Relay 1 ON/OFF and Auto/Manual Control	Repurge Cycles	Lock Mode	Relay 2 ON/OFF and Auto/Manual Control	Aux TC Pressure
Relay 2 ON/OFF and Auto/Manual Control	Base Pressure	Parameter Lock		Cryopump
	Rate-of-Rise (ROR)	Zero Auxiliary Thermocouple		REGEN Track
	ROR Cycles	Zero Cryopump Thermocouple		Rough Valve
	Rough Valve Interlock	First Stage Temperature Control		Time Delay
	Power Fail Recovery			
	Power Fail Recovery Temperature			

This Page Intentionally Left Blank

Section 4 - On-Board Module Replacement

Module Ordering Information

The serial numbers of the On-Board Cryopump and On-Board Module must match to ensure module/pump calibration. Refer to **Appendix A** and be prepared to provide the CTI-CRYOGENICS Service Representative with the following information when requesting a replacement On-Board Module:

- Pump Serial Number
- On-Board Module Part Number and Serial Number
- Number of Hours on Pump

CTI-CRYOGENICS will ensure that the existing module serial number is programmed into the replacement module to maintain the calibration integrity of the On-Board System.

Module Replacement

NOTE: *The existing On-Board Module may be programmed to specific user defined process parameters. The replacement module must be programmed to restore the user defined parameters once installed.*

1. Set the On-Board power switch located on the compressor or compressor controller to the OFF position.
2. Remove all cables from the *Power In, AUX TC, Remote, Relays, Network,* and *RS-232* connectors as shown in Figure 4-1.
3. Using a straight blade screwdriver, loosen the safety interlock screw until the On-Board Module is released from the module housing. Slide the On-Board Module out of the housing.

NOTE: *Make sure the safety interlock screw is completely tightened during step 4 to ensure that the module circuit board is inserted into the housing connector.*

4. Insert the new On-Board Module into the module housing and tighten the safety interlock screw.

NOTE: The safety interlock screw must be in the vertical position before the Power In cable can be connected. If necessary, turn the screw out 1/4 turn to set the screw in a vertical position as shown in Figure 4-1.

5. Connect the cables removed during Step 2.
6. Set the On-Board power switch to the ON position.
7. Refer to **Section 3 - Programming and Operation** to program the new On-Board module.

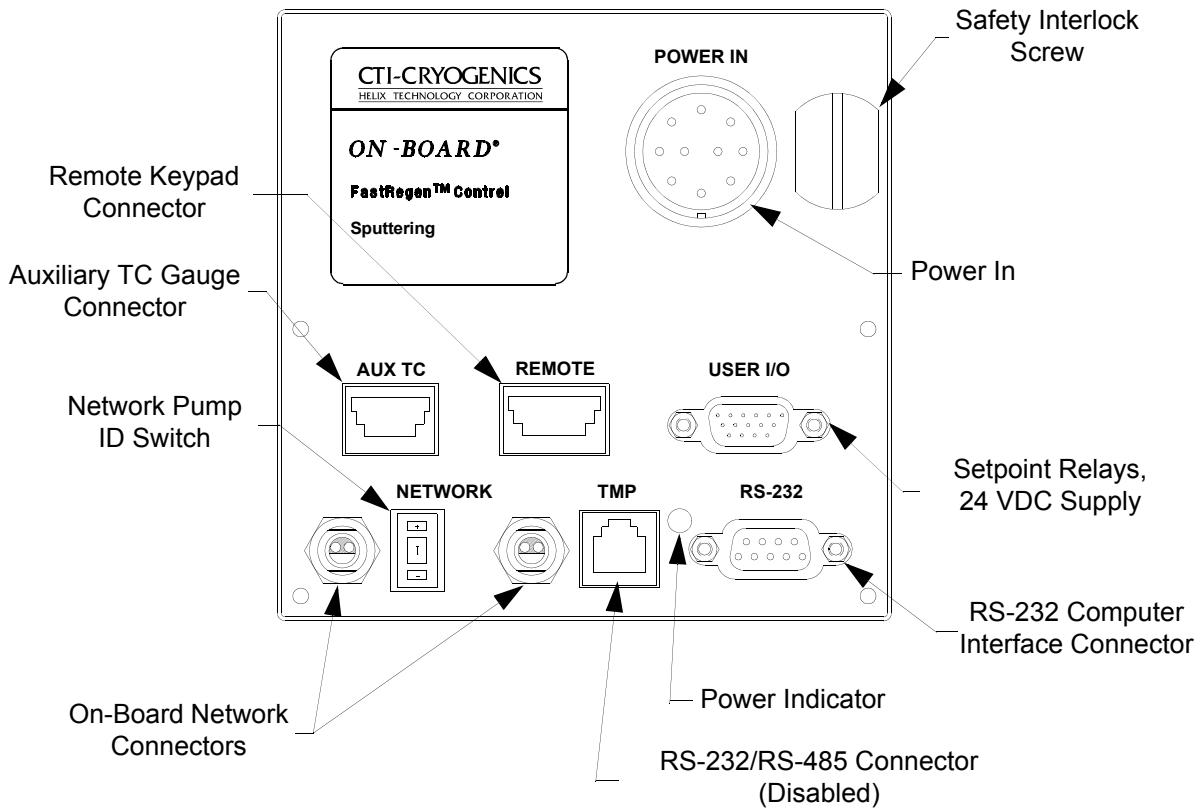

Figure 4-1: On-Board FastRegen Control Module Component Location

Appendix A - Customer Support Information

Customer Support Center Locations

To locate a Customer Support Center near you, please visit our website www.helixtechnology.com on the world wide web and select *CONTACT* on the home page.

Guaranteed Up-Time Support (GUTS)

For 24 hour, 7 day per week Guaranteed Up-Time Support (GUTS) dial:

800-367-4887 - Inside the United States of America

508-337-5599 - Outside the United States of America

Product Information

Please have the following information available when calling so that we may assist you:

- Product Part Number
- Product Serial Number
- Product Application
- Specific Problem Area
- Hours of Operation
- Equipment Type
- Vacuum System Brand/Model/Date of Manufacture

E-mail

For your convenience, you may also e-mail us at:

techsupport@helixtechnology.com

This Page Intentionally Left Blank

Appendix B - On-Board Module RS-232 Interface Protocol Format

The format of RS-232 messages between a computer device (the HOST) and the On-Board module (slave) is the same for both directions of message flow (HOST transmitted or slave transmitted). Each message consists of a series of ASCII characters transmitted via a standard RS-232 asynchronous framing convention of one (1) start bit, seven (7) data bits, a parity bit generated for even parity, and one (1) stop bit; at a transmission rate of 2400 baud.

The message packet is composed of a starting flag character (the \$ character, hex 24), followed by a message dependent data field, followed by a message checksum character, terminated by an ASCII carriage return code (hex 0D). The starting flag character serves the unique purpose of synchronizing the receiver to the transmitter, by signaling the start of the message packet. This '\$' code is not contained in the set of characters used to construct the data field or the checksum character, and therefore establishes a fixed reference point to sync up data flow. Whenever either receiver (HOST or slave) receives a '\$' character, all history and status of previous partial packet data (if any) is aborted and lost, and a packet message is started anew.

The data field consists of from one (1) to a maximum of fourteen (14) ASCII characters, the meaning of which is defined in the Pump Command List for commands and responses. All characters with the exception of '\$' and Carriage-Return (0D hex) may be employed in the data field, if suitable.

The message checksum character is employed to guard against garbled or incorrect messages being received and acted upon, causing undesirable or damaging results. Only messages which are conveyed accurately and intact from the master to slave (or visa versa) are accepted and acted upon. The checksum character which follows the data field is computed by a modified binary sum technique (described later) over the characters composing the data field. The transmitting unit generates this sum based on the characters it used to produce the data field, and appends it after the field just prior to the CR code terminator. The receiving unit performs the same checksum algorithm on all characters which it receives between the '\$' character and the character just prior to the CR terminator (non-inclusive).

If this sum matches the final character preceding the CR terminator, then the message is validated and processed by the receiver. If not, then an error has occurred and the action taken depends on whether the receiver is the HOST or slave unit. The checksum algorithm generates a character between ASCII '0' and 'o' (30 hex to 6F hex) inclusive.

The checksum algorithm is defined as follows: Perform the 8 bit (modulo 256) sum of all the ASCII characters sent in the data field (with the most significant bit cleared to 0, ignore parity). This is performed for one to fourteen character code bytes. Fold the resulting eight bit sum into six bits by exclusive oring the two MSBs of the sum (D7, D6) with the two LSBs (D1, D0) of the sum such that the new D1 is the old D1 XOR D7 and the new D0 is the old D0 XOR D6. The resulting lower six bits (D5 . . D0) are then masked off, producing a code range of from 00 to 3F hex. This is then added to the ASCII code for '0' (30 hex), generating the final printable checksum character in the range of 30 hex to 6F hex ('0' . . 'o').

Message traffic is always originated by the HOST unit. This message is referred to as a command or query. Commands cause specific actions to occur in the On-Board Module. Queries request that the On-Board Module reply with status or other parametric information. The On-Board Module responds to all such correctly received messages with a response message. The pairing of these command-response or query-response message sets defines a transaction or exchange. If a faulty message is received by the On-Board Module (due to improper production in the host, or transmission media failure), the message is discarded and no response is sent back to the host as a reply. The host must be able to detect that either no response or an invalid response was received from the slave (through time-out and checksum detection), and if desired, repeat the message to the slave in an attempt to secure a valid transaction.

All communications between a host computer and the On-Board Module will occur within this message transaction framework. Software operating on the host computer must generate and interpret the message-response pairs to properly execute and control remote operation and data-logging of the On-Board Module. Software within the On-Board Module interprets these valid messages and returns appropriate replies, as documented in the On-Board Module RS-232 command list. Error code messages may be returned by the On-Board Module if a valid message packet is received but the data field contents are not correct and cannot be interpreted. This is not a communications error, but a software error. Invalid commands, improper parameter ranges, or requests to perform operations which are disallowed for some reasons all result in an error message reply.

There are three categories of error messages. Each category has two possible messages. The first is an error under normal conditions. The second is an error message that also signals a recent power loss. If a power loss signal is received, this flag can be reset by using the S command .

1. The normal reply for an understandable and executable message is A. If this inquiry is the first since a power failure, the message is B.
2. If a command is sent that cannot be executed under any conditions, the error message is E. If this inquiry is the first since a power failure, the message is F.
3. If a command is sent that cannot be executed except under certain conditions, due to interlocks, the return message is G. If this inquiry is the first since a power failure, the message is H.

NOTE: *If using a Network Terminal or On-Board Central Control software, the only reply you will see will be "A". This reply occurs because the error messages will have been cleared by the Network Terminal or On-Board Central Control software. If your system utilizes a Network Terminal or On-Board Central Control software, you should use the lower case t command as described in Table B-1 (within this appendix) and Appendix E if you wish to have your system controller recognize a power failure signal which is recorded in the pump.*

Between the time that the host sends a command/ query and the slave returns a response message, further characters sent from the host to the slave are ignored. The slave will respond to any verified message packet it receives within one second. A timeout period in excess of this within host can be used to detect a failure and need to re-try. Once a response to a message has been received by the host, new command/query messages may be immediately sent out (at a rate that will be faster than the one-second turnaround timeout). In this way the message traffic is self synchronizing.

The following is an example of a typical exchange:

Host sends query to get back On-Board Module version information

	Flag	Data Field	Checksum	Terminator
ASCII	[\$]	[@]	[1]	[CR]
Hex	[24]	[40]	[31]	[0D]

Checksum of hex 40 data field:

Bits 76543210
 Sum = 40 = 01000000
 Bits 7 and 6
 aligned for
 XOR 00000001
 XOR result 01000001
 Mask D5,D0 00000001
 Addend "0" 00110000
 Final Chk 00110001 Hex 31, ASCII "1"

Slave sends replay of AP A2.01, meaning no error, pump version A2.01.

	Flag	Data Field	Checksum	Terminator
ASCII	[\$]	[A] [P] [] [A] [2] [.] [0] [1]	[a]	[CR]
Hex	[24]	[41] [50] [20] [41] [32] [2E] [30] [31]	[61]	[0D]

Checksum of hex data field:

Bits 76543210
 Sum of
 41 01000001
 50 01010000
 20 00100000
 41 01000001
 32 00110010
 2E 00101110
 30 00110000
 31 00110001

equals 10110011 or hex B3 modulo 256.

Bits 7 and 6
 aligned for
 XOR 00000010
 XOR result 10110001 or B1
 Mask D5,D0 00110001
 Addend "0" 00110000
 Final Chk 01100001 Hex 61, ASCII "a"

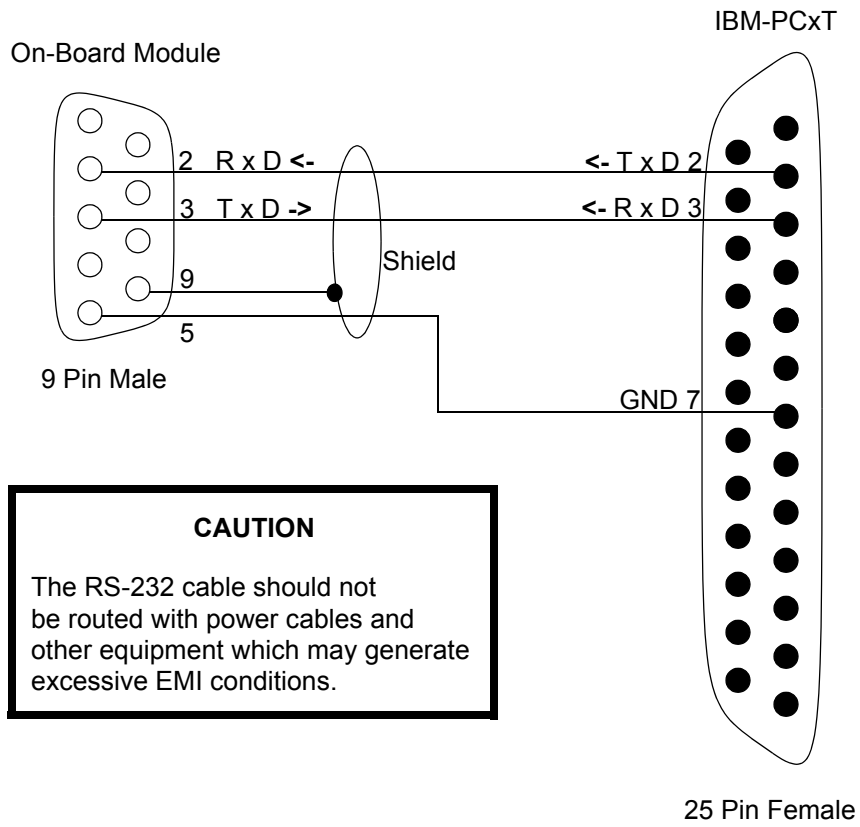

On-Board Module to IBM-PCxT

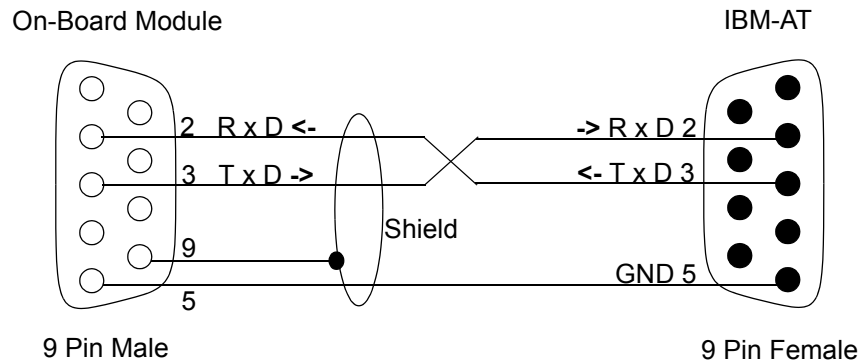

On-Board Module to IBM-AT

NOTE: Connectors should be of a metal case type and cable lengths should not exceed 40 feet.

Figure B-1: RS-232 Cable Connections

Table B-1: On-Board Module RS-232 Commands

Command	Parameter	Description
A	[0 - 1] [?]	Turns the pump ON and OFF and provides status: 0 - Turns pump OFF 1 - Turns pump ON ? - Provides pump status
B	[0 - 1] [?]	Turns the pump TC ON and OFF 0 - Turns TC OFF 1 - Turns TC ON ? - Provides TC status
C	[0 - 1] [?]	Turns the AUX TC ON and OFF. 0 - Turns PUMP AUX TC OFF 1 - Turns PUMP AUX TC ON ? - Provides AUX TC status
D	[0 - 1] [?]	Opens or closes the rough valve and provides status. 0 - Closes rough valve 1 - Opens rough valve ? - Provides rough valve status
E	[0 - 1] [?]	Opens or closes the purge valve and provides status. 0 - Closes purge valve 1 - Opens purge valve ? - Provides purge valve status
H	[0 - 320] [?]	Sets temperature control of the first stage. Temperature control is turned OFF if set to "0". A "?" reads back the current value of 0-320.
J	None	Sends back the first stage temperature.
K	None	Sends back second stage temperature.
L	None	Sends back the pump TC pressure.
M	None	Sends back the AUX TC pressure.
N	[0 - 2}	Starts or aborts a regeneration cycle. 0 - Aborts regeneration 1 - Starts regeneration 2 - Starts fast regeneration
O	None	Sends back the current regeneration step. Refer to Appendix C for the ASCII codes.

Table B-1: On-Board Module RS-232 Commands (Continued)

Command	Parameter	Description
P	[0 - 6,A,G,S] [5 digit number] [?]	Reads/Sets a regeneration parameter. 0 = Pump restart delay (minutes) range = 0 - 59994 1 = Extended purge time (minutes) range = 0 - 9999 2 = Repurge cycles 0 - 20 3 = Rough to pressure range = 25 - 200 4 = Rate-of-rise (microns/minute) range = 1 - 100 5 = ROR cycles range = 0 - 40 6 = Start-up temperature (after power failure) range = 0 - 80 A = Clear/set rough valve interlock range = 0 - 1 G = Repurge time (minutes) range = 0 - 9999 S = Fast rough test range = 10 - 999

Table B-1: On-Board Module RS-232 Commands (Continued)

Command	Parameter	Description
Q	[NONE] [?]	<p>Rough valve interlock. If no parameter is specified, the valve token is given to the pump. Once the pump has the token, it will keep it until it is done with the rough valve.</p> <p>During a query (?), the result bits are biased (arithmetically) with '0'. After subtraction of the bias a bit 0 ON (1) indicates that the pump has the token.</p> <p>A bit 0 ON (1) indicates that the pump has the token.</p> <p>A bit 1 ON (2) indicates the pump needs the valve token for REGEN.</p> <p>A bit 2 ON (4) indicates the cryopump is on (PUMP_ON is TRUE). This is used for auto-compressor power up.</p> <p>The following applies to a Full regeneration:</p> <p>Valid returns are '0' . . '7'. A '0' or '4' means that the pump has given the flag back.</p> <p>The following applies to a Fast regeneration:</p> <p>For Fast regeneration pumps, an additional character is added to the response and a fixed bit 3 weight (8) is always present in the first character telling the Network Terminal or other querying agent that a second byte follows with meaningful Fast regeneration flag information. This second character is '0' biased as the first, with new bit weights defined as follows:</p> <p>A bit 0 ON (1) indicates the pump needs the rough valve for a shared Fast regeneration.</p> <p>Valid returns are '0' or '4' for pump OFF/ON with no REGEN. Returns of '2', '3', '6', and '7' are normal REGEN need/got.</p>

Table B-1: On-Board Module RS-232 Commands (Continued)

Command	Parameter	Description
S	1 - 3	<p>Send back various status indicators.</p> <p>Status 1 01H = Pump ON 02H = Rough valve ON 04H = Purge valve ON 08H = Cryo TC ON 10H = Aux TC ON 20H = A result of 0 means that there was a power failure. The bit is reset to 1 after this query.</p> <p>Status 2 01H = Setpoint 1 ON 02H = Setpoint 2 ON 08H = First stage temperature control ON</p> <p>Status 3 01H = Pump phase 1 check 02H = Pump phase 2 check</p>

Table B-1: On-Board Module RS-232 Commands (Continued)

Command	Parameter	Description
T	[1-2] {[0-8,ABCF] [4 digit number] {[?][0,1,2,8]}	<p>This command programs the setpoint relays. The first parameter tells the relay number (1 or 2). The second parameter is one of two forms. The first, used for setting the item to be programmed, consists of a selector (0-8, ABCF). This form is followed by a third parameter, a 4 digit number, if the selector is 0 - 8. The A - F selectors do not require a following numeric parameter, as they are logical function settings.</p> <p>The second form is used to query the settings and consists of the "?" command element followed by a selector (0-2, 8) to indicate what data is being queried.</p> <p>Selector meaning for first form: 0 = Set first stage LL (deg Kelvin) 1 = Set first stage UL 2 = Set second stage LL (deg Kelvin) 3 = Set second stage UL 4 = Set Pump TC LL (microns) 5 = Set Pump TC UL 6 = Set AUX TC LL (microns) 7 = Set AUX TC UL 8 = Set time relay (0-9999 seconds) A = Set unconditional ON B = Set unconditional OFF C = Set as REGEN status tracking relay D = Set as rough valve tracking relay F = Set as pump motor ON/OFF status tracking relay</p> <p>Selector meaning for second form: 0:=Query previously set LL (meaning depends upon previous use) 1:=Query previously set UL (meaning depends upon previous use) 2:=Query last sent first form selector (0-7, A,B) used to establish particular relay function 8:=Query relay time delay (0-9999 seconds)</p> <p>Examples: "\$T 1 2 25" /* Set relay 1 second stage LL to 25K "\$T 1 8 30" /* Set relay 1 time delay to 30 seconds "\$T 1 ? 0" /* Query relay 1 last LL value "\$T 1 ? 2" /* Query mode of relay startup for relay 1, returns 0 - 7 A - F as characters</p>

Table B-1: On-Board Module RS-232 Commands (Continued)

Command	Parameter	Description
VA	[?]	Reads first 8 characters of pump serial number.
VQ	[?]	Reads remaining 3 characters of pump serial number (if any exist).
W	None	Returns the memory error code. During initialization, 3 memory areas are checked for errors. The first contains diode calibration constants and use data. The second area contains regeneration parameters. The third contains history data. A return character of @ means there were no errors. Bits are set to indicate errors. The first area will be indicated by setting the LS bit, second area by bit 1, and third area by bit 2
Y	?	Read elapsed time. The units are in hours and expressed as an integer. The range is up to 65,000 hours.
Z	[?]	Read the number of REGEN cycles that have been completed.
@	None	Returns an identifier string indicating module type and software revision level.
a	None	Read back how long it has been since the last Full regeneration cycle. The units are in hours.
a 2	None	Read back how long it has been since the last Fast regeneration cycle. A Full regeneration will reset both a and a2 to zero. The units are in hours.

Table B-1: On-Board Module RS-232 Commands (Continued)

Command	Parameter	Description
e	None	<p>Read error code result of REGEN operation. Returns one of eight characters as defined in Appendix C, should only be used when REGEN response V is returned.</p> <p>@ - No error A - WARMUP TIMEOUT. Did not reach warmup temperature within 60 minutes. B - COOLDOWN TIMEOUT. Did not cool down within 5 hours. C - Error in rate of roughing (2% per minute). D - ROR CYCLE LIMIT WAS REACHED. The pump did not pass the rate-of-rise test within the programmed cycle limit. E - MANUAL ABORT. Someone manually gave the command to stop regeneration. F - ROUGH VALVE TIMEOUT. Rough valve was opened for more than 1 hour without closing. G - Caused by illegal state encountered, system bug. H - Start of Fast regeneration not allowed; pump too warm. I - TOO COLD TO ROUGH. Pump was too cold to rough to maintain base pressure.</p>
g	None	<p>Requests the auto calibration of the CRYO TC gauge. Returns a "G" or "H" error code if conditions are not valid to perform the auto zero calibrate, such as TC not turned ON or the pressure is too high.</p>
h	None	<p>Requests the auto calibration of the AUX TC gauge. Returns a "G" or "H" error code if conditions are not valid to perform the auto zero calibrate, such as TC not turned ON or the pressure is too high.</p>
i	[0,1,2,?]	<p>Set/Clear/Query the power fail recovery flag.</p> <p>0 - Power Fail Recovery turned OFF 1 - Power Fail Recovery turned ON 2 - Power Fail Recovery if below power failure temperature limit ? - Provides Power Fail Recovery status</p>
j	[0..59994, ?]	<p>Pump delay to start of regeneration cycle (minutes).</p>

Table B-1: On-Board Module RS-232 Commands (Continued)

Command	Parameter	Description
k	None	Returns an internal interval timer value in minutes. When in the appropriate phase, this value represents the time remaining in the phase (delay start, cryo restart, purge time). Times from 1 to 60 seconds return as 1 minute. Times from 61 seconds to 120 seconds return as 2 minutes. Zero returns as 0 minutes.
l	None	Returns the number of failed purge cycles as an integer value. This value starts at "0" and increments each time a purge phase fails.
m	None	Returns the number of failed and extended ROR test cycles as an integer value. This value starts at "0" and increments each time a ROR test phase fails.
n	None	Returns the last measured ROR value computed during a ROR test cycle as an integer value. This value matches that presented on the keypad/display.
r	P X, form is rP or rX	<p>Polls an event count value which specifies the completion of either the pump (P) or AUX (X) TC auto zero sequence. This value is used by a remote computer to tell when an initiated auto zero is complete.</p> <p>Returns a modulo 256 (0-255) numeric value which is incremented each time the auto zero operation completes. The remote unit can detect the completion of the event by a change in value.</p>
s	None	Polls an event count modulo 256 (0-255) which is incremented each time a REGEN cycle is performed. Used to indicate whether the REGEN idle message should be REGEN COMPLETE or REGEN OFF.
t	? =, form is t? or t=	Command to either inquire (t?) or acknowledge and clear (t=) the power recovery flag. A response of 1 is COOLDOWN, 2 is REGENERATION, 3 is IN PROCESS, 4 is RECOVERED, 5 is CHECK PUMP TEMP. Clear the flag with the t= command after inquiring on the flag value.
u	None	Inquires pump for information in byte fail_cause of pump, which contains 0 if AC to pump OK, else bits 4,5 set for fail of each phase. Codes are @, P,p. Used to display of power phase information of pump. OFF, ON, ERR1, and ERR2.

Table B-1: On-Board Module RS-232 Commands (Continued)

Command	Parameter	Description
v	None	<p>Inquires pump for several regeneration flag conditions combined as bits in one response. The bits are biased by "@" for ASCII printable results. The bit weights are:</p> <p>01H - Waiting for rough valve. 02H - Purge gas failure detected in regeneration. 04H - Heater failure detected in regeneration 08H - Fast regeneration has recovered from purge gas failure. 10H - Fast regeneration crossed over to a full regeneration. 20H - True when fast regeneration has started.</p>
z	[0,1, ?]	<p>Set/Clear/Query the user keypad access lockout state. When True, the user is limited to the use of the MONITOR and SERVICE functions on the keypad/display.</p>
[B	1 - 2	<p>Restore relay 1 or 2 to automatic settings from manual mode.</p>

Appendix C - RS-232 Regeneration Responses

Introduction

Appendix C describes the On-Board Cryopump REGEN responses which are requested by host computer O status command. The regeneration responses inform the host computer of the regeneration cycle status of the On-Board Cryopump.

NOTE: In some cases there are several responses which mean the same thing.

Regeneration Response Description

Refer to Table C-1 for a complete description of the regeneration responses.

NOTE: Regeneration responses identified with an asterisk () apply to FastRegen responses. Regeneration responses not identified with an asterisk apply to Full regeneration responses.*

Responses to the O command are A - z (equal to numeric codes 0 - 57 and 58 - N). The numeric return information is preceded by the plus sign (+).

Table C-1: RS-232 REGEN Responses and Descriptions

REGEN Response	Description
A,\	Cryopump OFF
B, C, E , ^,]	<p>WARM-UP - During warm-up you may also want to display the actual second stage temperature and the temperature it is attempting to reach.</p> <p>Example: WARM-UP 272K/310K The 310 is fixed and the 272 is the response from the command K.</p>
D, F, G, Q, R	<p>PURGE GAS FAILURE - means that there is a failure with the purge gas. The On-Board Module will not turn the heaters on and the warmup temperature is reduced to 285K. You should be aware that there is a problem with the purge gas when this response appears. The D response means purge gas fail if the response to "v" is equal to 8. If the response to "v" is 4, the heater failure message should be displayed.</p> <p>Example: PURGE GAS FAILURE. . .WARM-UP 234K/285K</p>
H, S	<p>EXTENDED PURGE REPURGE CYCLE</p> <p>This response is used in conjunction with lowercase l and k</p> <p>An H response means that the pump has reached its warm-up temperature and the purge is being extended for some amount of time. The time is determined when the regeneration parameters are programmed. If the response to l is 0, then this is called EXTENDED PURGE. If the response to l is greater than 1, then this is called REPURGE CYCLE. The time remaining in minutes is command k.</p> <p>Example: EXTENDED PURGE 12 MIN l = 0 k = 12 REPURGE CYCLE 9 MIN l = 1 k = 9 REPURGE CYCLE #2 5 MIN l = 2 k = 5</p>

Table C-1: RS-232 REGEN Responses and Descriptions (Continued)

REGEN Response	Description
<p>I,J,K, T, a*, b*, j*, n*</p>	<p>ROUGH TO BASE</p> <p>Purging is completed and the pump is being roughed to a base pressure. This is displayed showing the actual pressure, and the base pressure it is attempting to reach. The commands for this information are</p> <p>L actual pressure P3? Pressure attempting to reach (programmed value)</p> <p>Example: ROUGH 325u/100u = ROUGH actual pressure/try to reach pressure ROUGH L u/P3?u</p> <p>NOTE: If this is a multi-pump system, the pump roughing valve may be waiting to use the valve.</p> <p>The valve use is controlled by a token pass. Use the following command to access this information,</p> <p>Command Q? A response of 1 means the pump has the token. A response of 2 means the pump needs the token.</p>
<p>L</p>	<p>ROR (Rate-of-Rise): In this display we show how many rate-of-rises have been done the actual rate-of-rise and the rate-of-rise it is attempting to reach (the programmed value).</p> <p>The commands for this information are:</p> <p>m ROR# n Last ROR value (actual rate-of-rise for most recent test) P4? Programmed value for ROR</p> <p>Example of Display: ROR #1, 34/10 u/MIN ROR #m, n/p4? u/MIN</p>

Table C-1: RS-232 REGEN Responses and Descriptions (Continued)

REGEN Response	Description
M,N, c*, d*, o*	<p>COOLDOWN</p> <p>This display shows the actual second stage temperature and the target temperature which is always 17K. The command is: K actual temperature</p> <p>Example of Display: COOLDOWN 125K/17K</p>
P	Regeneration complete
U*	Begin Fast regeneration
V	<p>REGENERATION ABORTED</p> <p>If regeneration is aborted, the reason for this can be determined by using command e. The responses and descriptions are listed below:</p> <p>@ - No error</p> <p>A,B - WARM-UP TIMEOUT - Did not reach warm-up temperature within 60 minutes.</p> <p>C - COOLDOWN TIMEOUT - Did not cool down within 5 hours.</p> <p>E - ROR CYCLE LIMIT WAS REACHED - The pump did not pass the rate-of-rise test within the programmed cycle limit.</p> <p>F - MANUAL ABORT - Someone manually gave the command to stop regeneration.</p> <p>G - ROUGH VALVE TIMEOUT - Rough valve was opened for more than 1 hour without closing.</p> <p>I* - Not cooled <50. Start of Fast regeneration not allowed because the pump is too warm.</p>

Table C-1: RS-232 REGEN Responses and Descriptions (Continued)

REGEN Response	Description
W	<p>DELAY RESTART</p> <p>This countdown timer delays starting the pump for cooldown mode after it has been warmed up, roughed out, and passed the ROR test. This is a user programmed value. If the pump has no valves, the delay timer begins when the pump reaches 310K.</p> <p>To get the timer value in minutes, use the command k. <i>NOTE: Display the time in hours to match the keypad display.</i></p>
X, Y	<p>POWER FAILURE</p> <p>There was a power failure during the regeneration cycle and the pump will make a decision to cooldown or regenerate. Refer to Appendix D for more information.</p>
Z	<p>DELAY START</p> <p><i>NOTE: Applies to Full and Fast Regeneration cycles.</i></p> <p>The start of regeneration will be delayed for some time. To get the timer value in minutes, use command k. <i>NOTE: Display the time in hours to match the keypad display.</i></p>
O, [<p>ZEROING TC GAUGE</p> <p>The TC gauge is being zeroed at the end of regeneration.</p>
f*	<p>SHARE REGEN WAIT</p> <p>Waiting to lock/acquire shared use of rough valve for multi-pump Fast regenerations when using the Network Terminal and the rough valve interlock.</p>
e*	<p>REPURGE</p> <p>This is the special repurge cycle in Fast regeneration that initiates after the pump has failed to rough to the rough test pressure within the customer programmed time.</p>

Table C-1: RS-232 REGEN Responses and Descriptions (Continued)

REGEN Response	Description
h*	<p>PURGE COORD WAIT</p> <p>The pump is in a wait mode, waiting for all of the pumps to begin the re-purge cycle. The Fast regeneration process and Network Terminal coordinates the valves to re-purge simultaneously.</p>
i*	<p>ROUGH COORD WAIT</p> <p>The pump is in a wait mode, waiting for all of the pumps to begin roughing. The Fast regeneration process and Network Terminal coordinates the valves to rough simultaneously.</p>
k*	<p>PURGE GAS FAIL, RECOVERING</p> <p>At the start of the Fast regeneration, the pump failed the purge gas test. The pump was still coldenough at the end of the test and is attempting to recover back to 17K.</p>
l*,m*,n*,o*,p*,q*,r*,s*,t*,u*,v*,w*	<p>WARMUP</p> <p>During warmup, you may also display the actual 2nd-stage temperature.</p> <p>Example: Warmup 68K. The 68K is the response from command K.</p>

Appendix D - RS-232 Power Failure Recovery Messages

Introduction

Appendix D describes the On-Board Cryopump power failure recovery messages which are requested by host computer commands. Power failure recovery messages inform the host computer of the power failure recovery status of the On-Board Cryopump.

Table D-1: Power Failure Recovery Messages

Host Command	Response
t?	0 - No power failure has occurred 1 - Pump was in regeneration and is continuing to cool down. 2 - Pump is in regeneration. 3 - Pump is ON and attempting to recover to 17K. 4 - Pump has recovered from the power failure. 5 - Pump did not recover to 17K within 20 minutes. Check the temperature. 6 - Pump is above power failure temperature setpoint and is programmed to remain OFF.
t=	Clears the power failure flag.

***NOTE:** If using a Network Terminal or On-Board Central Control software, you may not see a power reset flag such as a "B" prefix to the return flag. This reply occurs because the error messages will have been cleared by the Network Terminal or On-Board Central Control software. If your system utilizes a Network Terminal or On-Board Central Control software, you should use the lower case "t" command as described in **Appendix B** and **Appendix E** if you wish to have your system controller recognize a power failure signal which is recorded in the pump.*

This Page Intentionally Left Blank

Appendix E - On-Board Keypad/Display Error Messages

Introduction

Appendix E describes the fault messages that can be tested for in the On-Board Module. Currently, each module must be polled for this information. The module does not automatically send an error message.

Table E-1: Keypad/Display Error Messages

Error Message	Response	Error Condition
No Pump Power (S3)	Logically AND the response with 01H	A result means that 1 phase of power is missing.
	Logically AND the response with 02H	A result means that both phases of power are missing.
Heater Failure (v)	Logically AND the response with 04H	If TRUE, a heater problem exists and the pump warm-up temperature is reduced to 285K.
	Logically AND the response with 01H	If TRUE, rough valve contention exists.
	Logically AND the response with 02H	If TRUE, no purge gas was detected and the warmup temperature is reduced to 285K.
CRYO TC Gauge interlock (B1)	A response of G or H as the first letter after the \$ in the response string	Indicates the CRYO TC gauge cannot be turned ON because the temperature of the second stage is above 20K.

This Page Intentionally Left Blank

Appendix F - User I/O

Introduction

The On-Board FastRegen Control Module with 24 VDC Supply provides a 24 VDC supply at the User I/O connector.

The On-Board FastRegen Control Module contains two relays and a 24VDC power supply. Relays 1 and 2 are programmable and are rated at one ampere @ 25 V AC/DC and have normally open (N.O.) or normally closed (N.C.) contacts.

All connections to the relays and 24 VDC power are made through the User I/O connector on the On-Board FastRegen Control Module shown in Figure F-1. The I/O Connector is a 15 pin, female, subminiature D, shell size 1 connector.

Refer to **Section 3 - Programming and Operation** for information on programming relays 1 and 2.

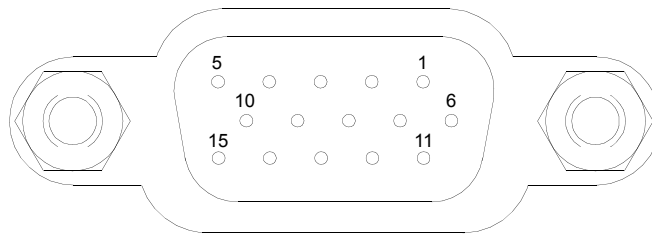

Table F-1: User I/O Connector Pin Assignments

Pin	Signal
1	Not Used
2	Relay 1 - Common
3	Not Used
4	Relay 2 - Normally Closed
5	Relay 1 - Normally Open
6	Not Used
7	Not Used
8	24 VDC Return
9	Relay 1 - Normally Closed
10	Not Used
11	Not Used
12	+ 24 VDC (100mA maximum)
13	Relay 2 - Common
14	Not Used
15	Relay 2 - Normally Open
Case	Earth Ground

Figure F-1: User Input/Output Connector Pin Assignments