

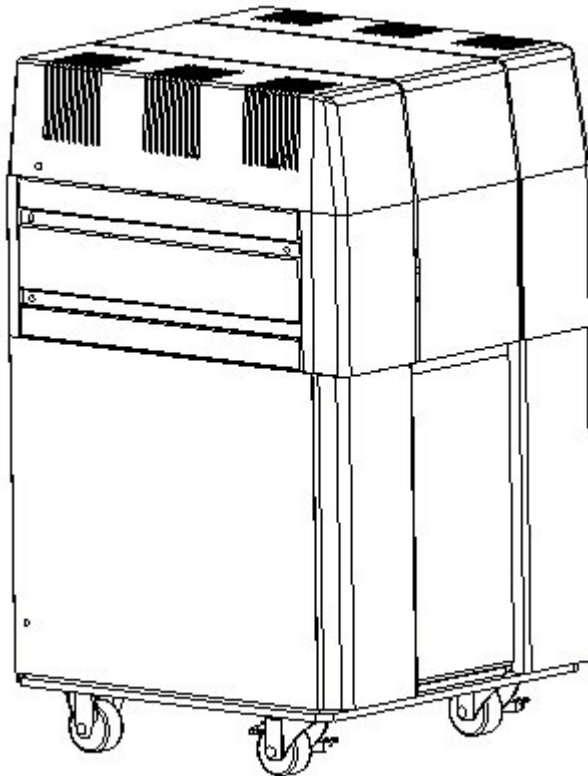

9700A HV and 9700A LV
Compressors
Installation, Operation, and
Maintenance User Manual



8040636 Revision B

Information provided within this document is subject to change without notice, and although believed to be accurate, Brooks Automation assumes no responsibility for any errors, omissions, or inaccuracies.

AcuLigner™, Align™, AquaTran™, AutoTeach™, ATR™, AXM™, Basic Blue™, BiSymmetrik™, CenterSmart™, Cool Solutions™, Crate to Operate™, e-RMA™, e-Spares™, e-Volution™, FastRegen™, FIXLOAD™, FrogLeg™, InLigner™, InCooler™, Interface™, Jet Engine™, LowProfile™, M2 Nano™, Mini-Ion™, PASIV™, PowerPak™, PerformanceBlue™, PowerPak™, PowerTools™, QuadraFly™, Radius™, Radiant™, Radiant Express™, Reliance™, Reliance ATR™, RetroEase™, SCARA™, SmartPM™, SPOTLevel™, Synetics™, The New Pathway to Productivity™, Time Optimized Trajectory™, Time Optimal Trajectory™, Time Optimized Path™, TopCooler™, TopLigner™, Ultimate Blue™, VAC-407™, VacuTran™, Vacuum Quality Monitor™, VQM™, Vacuum Quality Index™, VQI™, and the Brooks logo are trademarks of Brooks Automation, Inc.

AcuTran®, AquaTrap®, Conductron®, Convector®, the Cool Solutions logo, Cryodyne®, Cryotiger®, Cryo-Torr®, Fusion®, GOLDLink®, Granville-Phillips®, Guardian®, GUTS®, Helix®, Jet®, Leapfrog®, MagnaTran®, MapTrak®, Marathon®, Marathon 2®, Marathon Express®, Micro-Ion®, MiniConvector®, On-Board®, Polycold®, Razor®, Simplicity Solutions®, the Simplicity Solutions logo, Stabil-Ion®, TrueBlue®, TurboPlus®, Vision®, Zaris®, and the Brooks Automation logo are registered U.S. trademarks of Brooks Automation, Inc.

All other trademarks are properties of their respective owners.

© 2012 Brooks Automation, Inc. All Rights Reserved. The information included in this manual is Proprietary Information of Brooks Automation and is provided for the use of Brooks Automation customers only and cannot be used for distribution, reproduction, or sale without the express written permission of Brooks Automation. This information may be incorporated into the user's documentation, however any changes made by the user to this information is the responsibility of the user.



For Technical Support:

Location	GUTS® Contact Number
North America	+1-800-FOR-GUTS (1-800-367-4887) +1-978-262-2900
Europe	+49-1804-CALL-GUTS (+49-1804-2255-4887)
Japan	+81-45-477-5980
China	+86-21-5131-7066
Taiwan	+886-3-5525225
Korea	+82-31-288-2500
Singapore	+65-6464-1481

Visit us online: www.brooks.com

June 25, 2012 Part Num 8040636 Revision B
October 6, 2008 Part Num 8040636 Revision 16

This technology is subject to United States export Administration Regulations and authorized to the destination only; diversion contrary to U.S. law is prohibited.

Printed in the U.S.A.

Contents

Introduction

Compressor Configurations	1-1
System Documentation	1-1
BROOKS-CRYOGENICS Helium Refrigeration System	1-2
Compressor Specifications	1-4
Dimensions	1-4
Weight	1-4
Electrical	1-5
Cooling Water	1-5
General Operating Specifications	1-8
Component Description	1-10
System Circuit Breaker	1-11
Power ON Indicator	1-11
Elapsed Time Meter	1-11
Control Circuit Breaker	1-11
Power Cable Connector	1-11
Gas Charge Fitting	1-11
Helium Pressure Gauge	1-12
Helium Return Coupling	1-12
Cooling Water IN	1-12
Cooling Water OUT	1-12
Casters	1-12
Helium Supply Coupling	1-13
Access Panel	1-13
Compressor Remote Connector	1-13
Cryopump Electrical Outlet	1-14
Multiple On-Board Cryopump Connections	1-15
Multiple Cryo-Torr Cryopump Connections	1-16
Facilities Specifications (High Voltage)	1-17
Facilities Specifications (Low Voltage)	1-18

Safety

Introduction	2-1
Hazard Alerts	2-1
Safety Icons	2-2
Signal Words	2-3
Text	2-4
References	2-4
Safety Labels on the Compressor	2-5

Unpacking and Inspection

Introduction	3-1
Shipping Carton Inspection	3-1
Removal from Shipping Carton	3-1
Using the Ramp	3-1
Using a Lifting Device	3-3
Compressor Inspection	3-4
Compressor	3-4
Helium Static Pressure Verification	3-4
Shipping Carton Contents	3-4

Installation

Introduction	4-1
Supply and Return Water Line Connections	4-2
Hard Water Lines	4-2
Flexible Water Lines	4-2
Electrical Connections	4-3
Power Cable Preparation	4-4
Phase Check	4-6
Connecting/Disconnecting Helium Flex Lines	4-7
Connecting	4-7
Disconnecting	4-8
Single On-Board Pump Connections	4-8
Single Cryo-Torr Cryopump Connections	4-9
Multiple On-Board Pump Connections	4-11
Helium Line Connections	4-11
Power Cable Connections	4-11
Multiple Cryo-Torr Cryopump Connections	4-13

Helium Line Connections.....	4-13
Power Cable Connections.....	4-14

Operation

Adjusting System Helium Pressure	5-1
Static Helium System Pressure Verification.....	5-1
Compressor Startup and Operation.....	5-2

Maintenance

Scheduled Maintenance	6-1
Adsorber Replacement	6-2
Adjusting System Helium Pressure	6-5
Reducing Helium Pressure.....	6-5
Increasing Helium Pressure	6-6
Adding Helium	6-6

Appendices

Overview.....	7-1
Appendix A: Contact Brooks Automation Technical Support Information	7-2
Appendix B: Flow Diagrams	7-3
Appendix C: Troubleshooting Procedures.....	7-4
Troubleshooting the Compressor	7-4
Technical Inquiries.....	7-4

This Page Intentionally Left Blank

1

Introduction

This product is intended for use by industrial customers and should be serviced only by Brooks or Brooks trained representatives. The service manuals and related materials are provided in English at no charge and are intended for use by experienced technicians. It is the responsibility of the user to obtain and assure the accuracy of any needed translations of manuals. If you require assistance please contact Brooks service department. Contact information can be found at - www.brooks.com.

This manual provides the information required to install, operate, and maintain the BROOKS-CRYOGENICS 9700A Compressor.

All personnel with installation, operation, and maintenance responsibilities should become familiar with the contents of the *9700A HV and 9700A LV Compressors: Installation, Operation, and Maintenance Instructions* (8040636), as well as all appropriate cryopump manuals, to ensure safe, high quality, and reliable system performance.

NOTICE

Refer to Appendix A to contact the local Customer Support Center for information on connecting 9700A Compressors to a manifold with other BROOKS-CRYOGENICS compressors.

Compressor Configurations

The 9700A Compressor supports either On-Board or Cryo-Torr Cryopumps. For multiple cryopump installations, an On-Board Splitter Box or Cryo-Torr Interface can be used for cold head power distribution that reduces total cable requirements as shown in [Figure 1-7](#) and [Figure 1-8](#).

System Documentation

The system manuals cover the cryopump and the compressor. A manual is shipped with each component to install and operate that component.

BROOKS-CRYOGENICS Helium Refrigeration System

The operation of BROOKS-CRYOGENICS' cryopumps is based on a closed loop helium expansion cycle. The *system* is made up of the cryopump, which contains the cold head, and the helium Compressor which compresses the helium gas.

Refrigeration is produced in the cryopump cold head through periodic expansion of high pressure helium in a regenerative process. The high pressure helium is provided by the Compressor. Low pressure helium returning from the cold head is compressed to the necessary high pressure to be returned to the cold head. The energy required to compress the helium is rejected as heat through the cooling water.

High pressure room temperature helium is transferred to the cold head through the supply lines. After expansion, low pressure helium is returned to the Compressor (at or near room temperature) to repeat the cycle in a closed loop fashion. Large separation distances can be accommodated between the Compressor and the cryopump.

In the Compressor, helium is compressed using a highly reliable, oil-lubricated commercial Compressor. Helium purification takes place via several stages of oil removal. The final stage of purification is performed with a replaceable adsorber cartridge. To maintain peak efficiency, the adsorber must be replaced every three years. The 9700A Compressor is shown in [Figure 1-1](#).

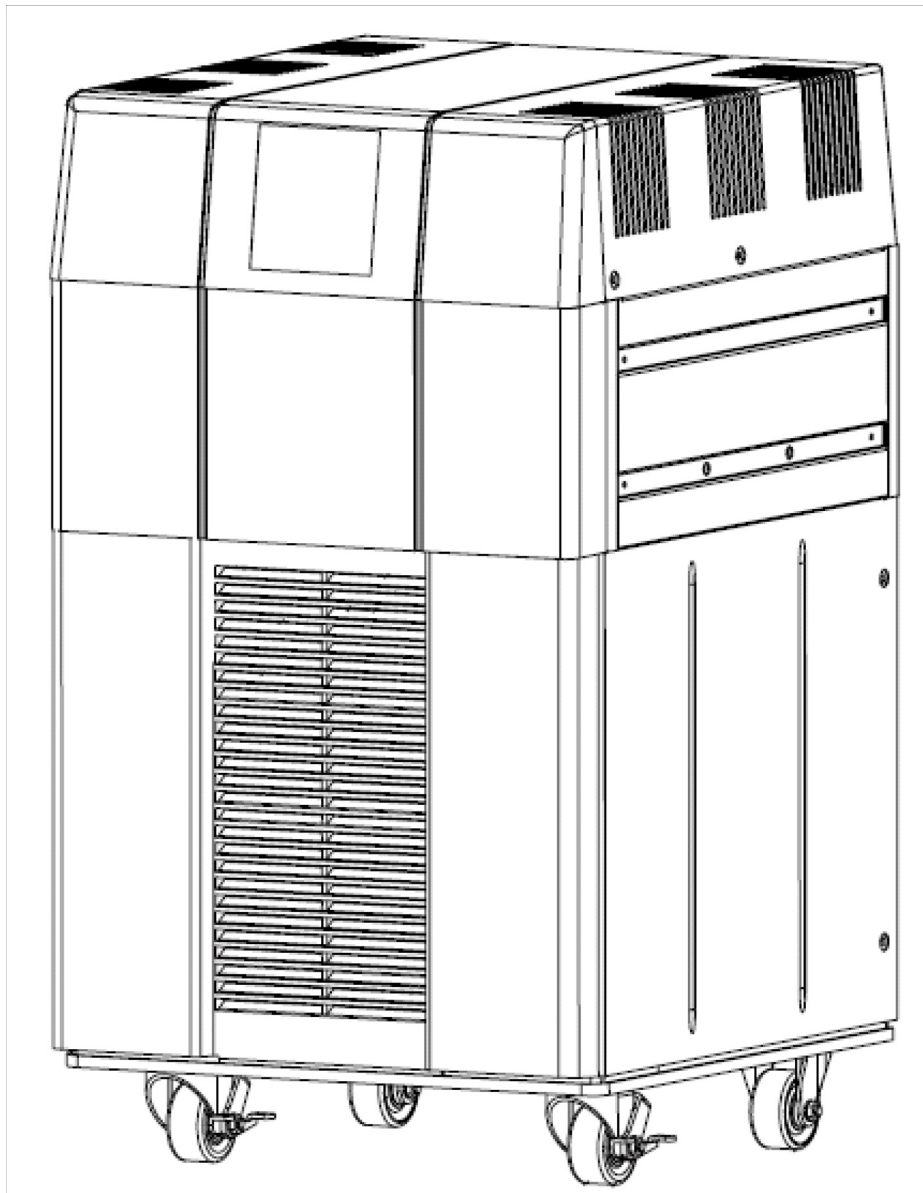

Figure 1-1: 9700A Compressor

Compressor Specifications

Dimensions

The dimensions of the 9700A Compressor are shown in Figure 1-2.

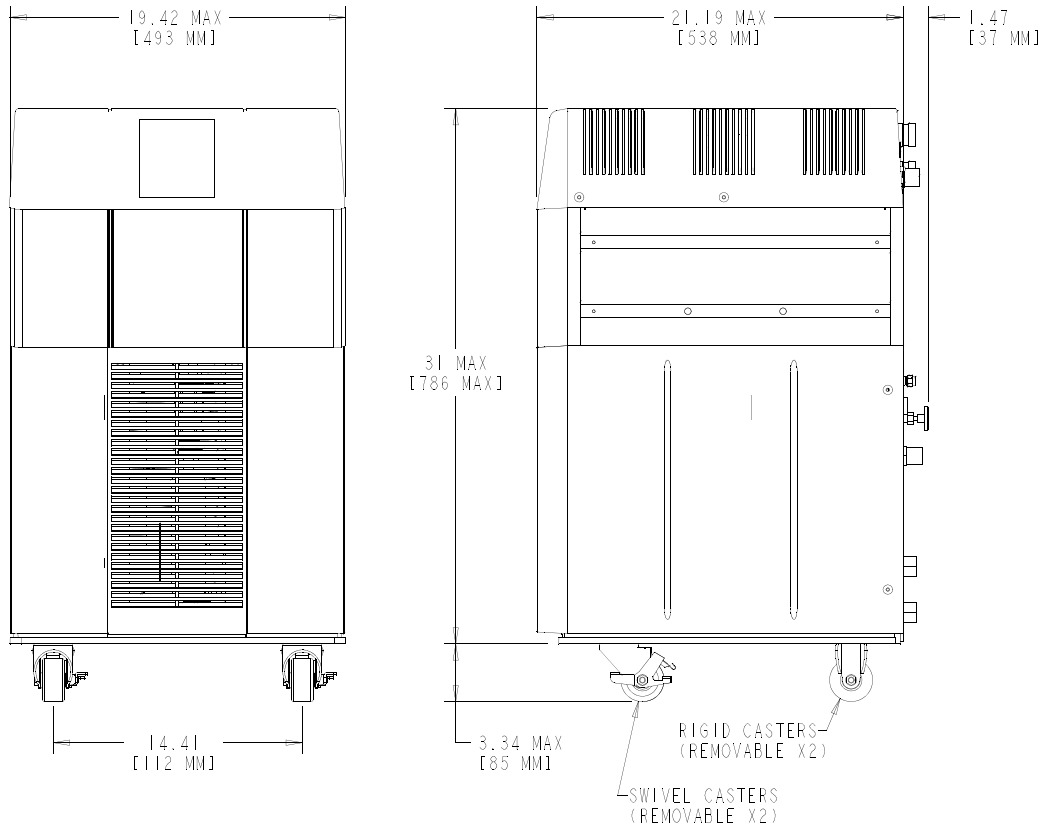

Figure 1-2: 9700A Compressor Dimensions

NOTICE

Do not place a weight greater than 34Kg (75 lbs) on top of the Compressor.

Weight

The Compressor weighs 159 kg/350 lbs.

NOTE: This includes 4.1 kg/9 lbs. of oil.

Electrical

The electrical specifications of the High Voltage Compressor are listed in [Table 1-1](#).

Table 1-1: High Voltage Electrical Input Specifications

Parameter	High Voltage
Operating Voltage Range/Frequency	380/480 50/60
Phase	3
Nominal Power Factor	0.9
Rated FL/LR ¹ Current	8/40 Amps
Minimum Electrical Service	15 Amps

1. Full Load/Locked Rotor

The electrical specifications of the Low Voltage Compressor are listed in [Table 1-2](#).

Table 1-2: Low Voltage Electrical Input Specifications

Parameter	Low Voltage
Operating Voltage Range	200/230 50/60
Phase	3
Nominal Power Factor	0.85
Rated FL/LR ¹ Current	17/85 Amps
Minimum Electrical Service	30 Amps

1. Full Load/Locked Rotor

Cooling Water

The water used to cool the Compressor must meet the specifications shown in [Table 1-3](#) for proper system operation.

Table 1-3: Cooling Water Specifications

Parameter	Value
Maximum Inlet Temperature ¹	90°F (32°C)
Minimum Inlet Temperature	50°F (10°C)
Flow Rate	3.0 ± 1.0 gpm (11.4 ± 3.8 lpm)
Pressure Drop (inlet-to-outlet)	See Figure 1-3
Maximum Inlet Pressure	100 psi (6.9 bars)
Alkalinity	6.0 - 8.0 pH
Calcium Carbonate	< 75 ppm

- See Figure 1-4 for minimum recommended water flow above 80° F inlet temperature. Water conditioning may be required for applications not meeting these requirements.

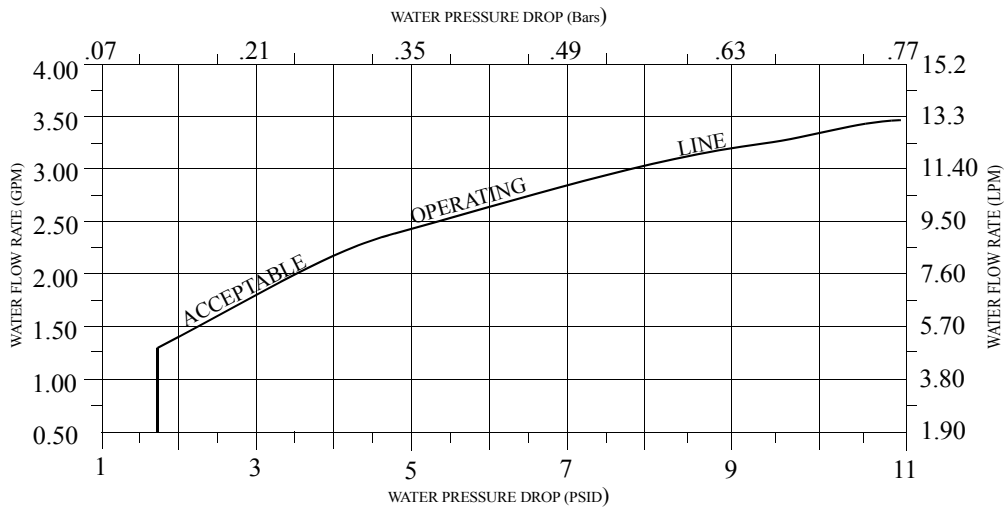

NOTE: Figure 1-3 defines the water flow rate through the Compressor as a function of the pressure drop from water inlet to water outlet. You must provide the correct pressure drop in your water supply system to ensure that the water flow condition meets the requirements specified in Table 1-3.

Figure 1-3: Water Flow Rate versus Pressure Drop

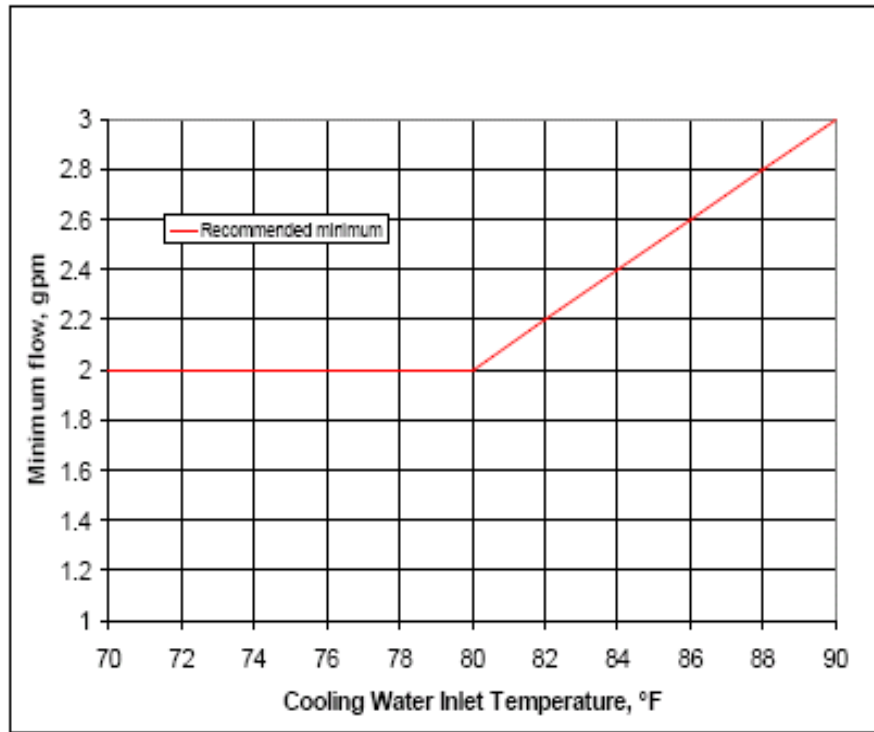

NOTE: Figure 1-4 shows that cooling water flow rate must be increased if the inlet temperature of the cooling water is above 80° F.

Figure 1-4: 9700A Cooling Water Flow Rate versus Inlet Temperature

General Operating Specifications

Table 1-4 provides general High Voltage Compressor operating specifications.

Table 1-4: General High Voltage Compressor Operating Specifications

Specification	Description
Input Power Cable	Must conform to local electrical codes. Must be installed by a qualified electrician.
Nominal Helium Pressure	Refer to Table 5-1 .
Ambient Environmental Conditions: Temperature Relative Humidity	50° - 100° F (10° - 38° C) 20% to 85% relative (non-condensing)
Interface	Cryopump Power Receptacle mates with the supplied cryopump power cable for single pump use. Mates with remote junction box power cable for multiple cryopump use.
Gas Supply Connector	1/2-inch Aeroquip self-sealing coupling
Gas Return Connector	1/2-inch Aeroquip self-sealing coupling
Remote Control Receptacle	24VAC, 2.7A inductive mates with P5 connector (Part Number 178127). Refer to Table 1-6 .
Fault Output	Pin C+D contact rated for 5A @250VAC or 5A @30 VDC
Adsorber Service Schedule	3 years

NOTE: *The 9700A Compressor is designed for continuous operation and should remain ON when the cryopumps are in a regeneration cycle.*

Table 1-5 provides general Low Voltage Compressor operating specifications.

Table 1-5: General Low Voltage Compressor Operating Specifications

Specification	Description
Input Power Cable	Must conform to local electrical codes. Must be installed by a qualified electrician.
Nominal Helium Pressure	Refer to Table 5-1.
Ambient Environmental Conditions: Temperature Relative Humidity	50° - 100° F (10° - 38° C) 20% to 85% relative (non-condensing)
Interface	Cryopump Power Receptacle mates with the supplied cryopump power cable for single pump use. Mates with remote junction box power cable for multiple cryopump use.
Gas Supply Connector	1/2-inch Aeroquip self-sealing coupling
Gas Return Connector	1/2-inch Aeroquip self-sealing coupling
Remote Control Receptacle	24VAC, 2.7A inductive mates with P5 connector (Part Number 178325). Refer to Table 1-7.
Adsorber Service Schedule	3 years

NOTE: *The 9700A Compressor is designed for continuous operation and should remain ON when the cryopumps are in a regeneration cycle.*

Component Description

The components of the 9700A Compressor that are accessible from the rear panel are shown in [Figure 1-5](#) and described in the following paragraphs.

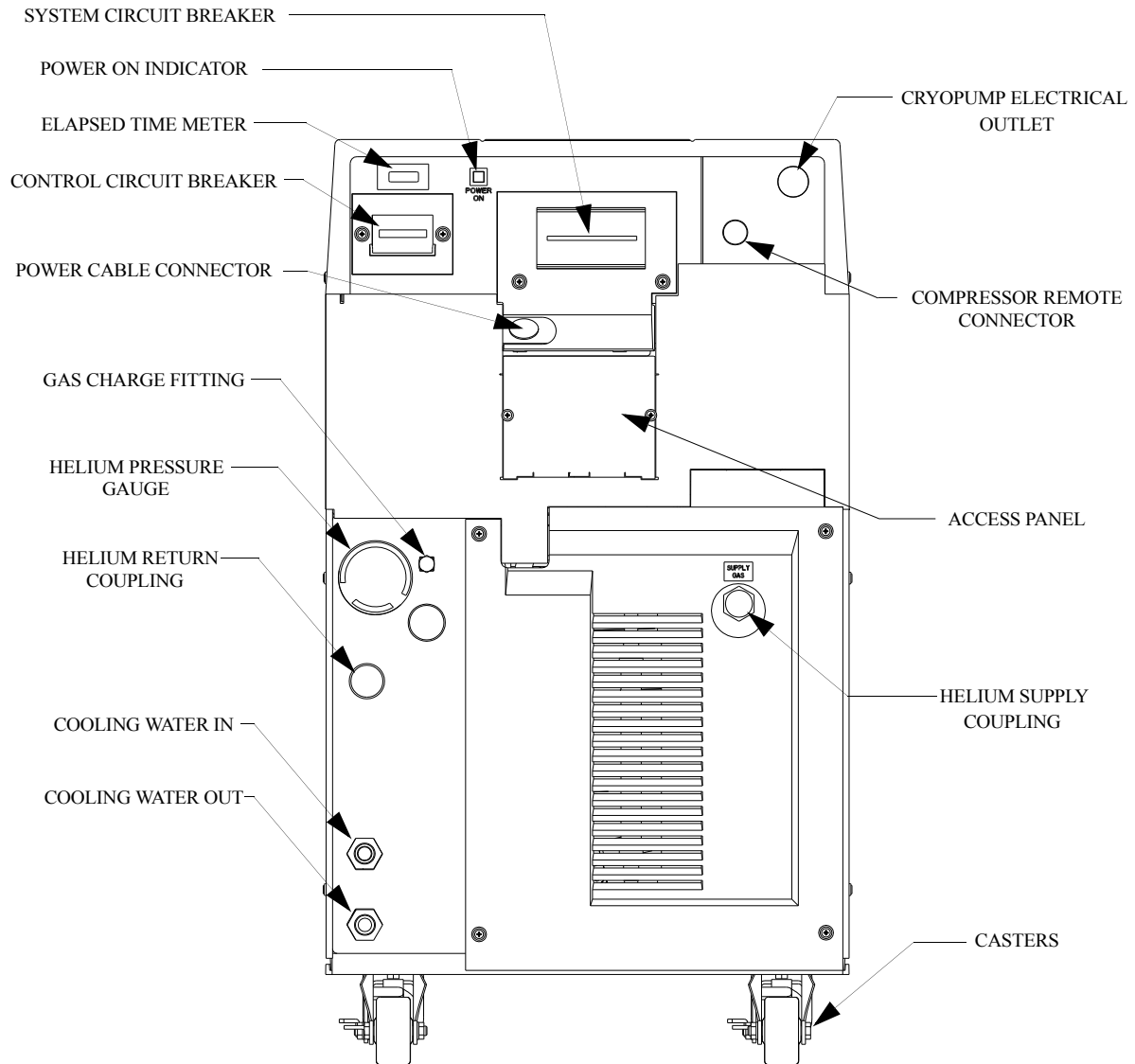

Figure 1-5: 9700A Compressor Rear View Component Locations

System Circuit Breaker

The System Circuit Breaker protects main input power to the Compressor pump and module. The circuit breaker positions are labeled ON (1), which is in the UP position, and OFF (0), which is in the DOWN position.

NOTE: *This is not to be used as a disconnect device.*

The phase monitor within the Compressor will cause the system circuit breaker to open when input power phases are incorrect.

Power ON Indicator

The Power On Indicator illuminates when the system circuit breaker is placed in the ON position. The Compressor pump is energized when the power indicator is illuminated, and the elapsed time meter records system operation time.

Elapsed Time Meter

The Elapsed Time Meter records the number of Compressor operating hours. Since the meter is digital, it is not illuminated unless the system circuit breaker is in the ON position, and power is connected to the Compressor. The Elapsed Time Meter maintains the correct accumulated operating hours while system power is turned OFF.

NOTE: *The meter cannot be reset.*

Control Circuit Breaker

The Control Circuit Breaker provides current overload protection for all internal components of the Compressor except the Compressor motor. The Compressor motor is protected by a separate overload protector. The Control Circuit Breaker opens automatically and must be reset manually.

Power Cable Connector

The Power Cable Connector connects the power cable to the Compressor. Refer to Chapter 3 for information on power cable installation.

Gas Charge Fitting

The Gas Charge Fitting is used to connect a 99.999% pure helium supply to the Compressor when helium charging is required. The fitting has a 45° flare and 7/16 in. x 20 threads/inch.

Refer to [Adding Helium](#) for information on adding helium to the Compressor.

Helium Pressure Gauge

The Helium Pressure Gauge indicates system static helium charge pressure when the Compressor and cryopumps are OFF and Compressor suction or inlet pressure when the Compressor is ON. Refer to [Table 5-1](#) for the appropriate static helium charge pressure.

Helium Return Coupling

The Return Gas Coupling returns the helium, which has been cycled through the cryopump, back to the Compressor. Refer to [BROOKS-CRYOGENICS Helium Refrigeration System](#) in this chapter for more information.

Cooling Water IN

The Cooling Water IN connector provides water to the Compressor from your facility to cool the Compressor during operation. The connector thread size is a 1/2 inch female pipe thread. The water must meet the specifications outlined in [Table 1-3](#). Refer to Chapter 4 - Installation [Supply and Return Water Line Connections](#) for more information on cooling water connections.

Cooling Water OUT

The Cooling Water OUT connector returns the water that has been used to cool the Compressor to your facility. The connector thread size is a 1/2 inch female pipe thread. Refer to Chapter 4 - Installation [Supply and Return Water Line Connections](#) for more information on cooling water connections.

Casters

The Casters allow the 9700A Compressor to be moved relatively easily.

NOTICE



The casters should be in the locked position after the 9700A Compressor has been installed to prevent compressor movement.

Helium Supply Coupling

The Supply Gas Coupling provides a connection for high pressure compressed helium to the cryopump cold head. Refer to [BROOKS-CRYOGENICS Helium Refrigeration System](#) in this chapter for more information.

Access Panel

The Access Panel protects the Compressor Power Cable connections.

 	 WARNING
	<p style="text-align: center;">Electric Shock</p> <p>Electric shock can cause severe injury or death. The Access Panel should not be removed from the 9700A Compressor until the power source has been turned OFF.</p> <p>Use the lockout/tagout procedure as defined by the facility in which the equipment is installed.</p>

Compressor Remote Connector

The Compressor Remote Connector is a 4-pin connector for high voltage and a 2-pin connector for low voltage that can be used in conjunction with the On-Board setpoint relays, relays in the Cryo-Torr Interface, or a signal from the vacuum system to turn the Compressor ON or OFF. Refer to [Table 1-6](#) and [Table 1-7](#) for connector pin identification. Switching contacts must be rated at 24VDC, 2.7A inductive.

NOTE: *The Compressor is shipped with a mating plug, which must remain installed in the Compressor Remote Connector to ensure Compressor operation when the Compressor remote feature is not being used.*

Table 1-6: High Voltage Compressor Remote Connector Pin Assignments

Identifier	Function
A and B	Compressor Remote Control - Make = ON, Break = OFF
C and D	No Fault = Contact Open, Fault = Contact Closed

Table 1-7: Low Voltage Compressor Remote Connector Pin Assignments

Identifier	Function
A and B	Compressor Remote Control - Make = ON, Break = OFF

Cryopump Electrical Outlet

The Cryopump Electrical Outlet provides power to a single On-Board or Cryo-Torr Cryopump, an On-Board Splitter Box, or a Cryo-Torr Interface. The Compressor requires the use of an On-Board Splitter Box or Cryo-Torr Interface for multiple cryopump system connections. Refer to [Table 1-8](#) for connector pin identification.

Refer to [Multiple On-Board Cryopump Connections](#) or [Multiple Cryo-Torr Cryopump Connections](#) in this chapter for more information.

Table 1-8: Cryopump Power Connector Pin Assignments

Identifier	Function
A and B	Heater Power - 200/230 VAC
C	Center tap for D and E
D and E	24 VCT @ 4.6 Amps
F-G and G-H	Cold Head Voltage
J	Chassis Ground
K	Not Used

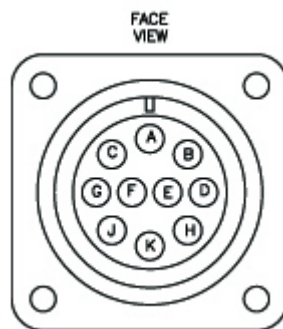

Figure 1-6: Power Connector Pin Assignments

Multiple On-Board Cryopump Connections

The On-Board Splitter Box permits the connection of multiple On-Board Cryopumps or Waterpumps to one 9700A Compressor as shown in [Figure 1-7](#). The actual number of On-Board Pumps that can be connected to the 9700A Compressor depends upon the process application and the type of On-Board pumps required.

NOTE: Refer to *Appendix A Customer Support Information* to consult with your local *BROOKS-CRYOGENICS Customer Support Center* for information on specific compressor/pump applications.

Refer to [Chapter 4: Installation](#) for more information on connecting single or multiple On-Board Cryopumps or Waterpumps to the 9700A Compressor.

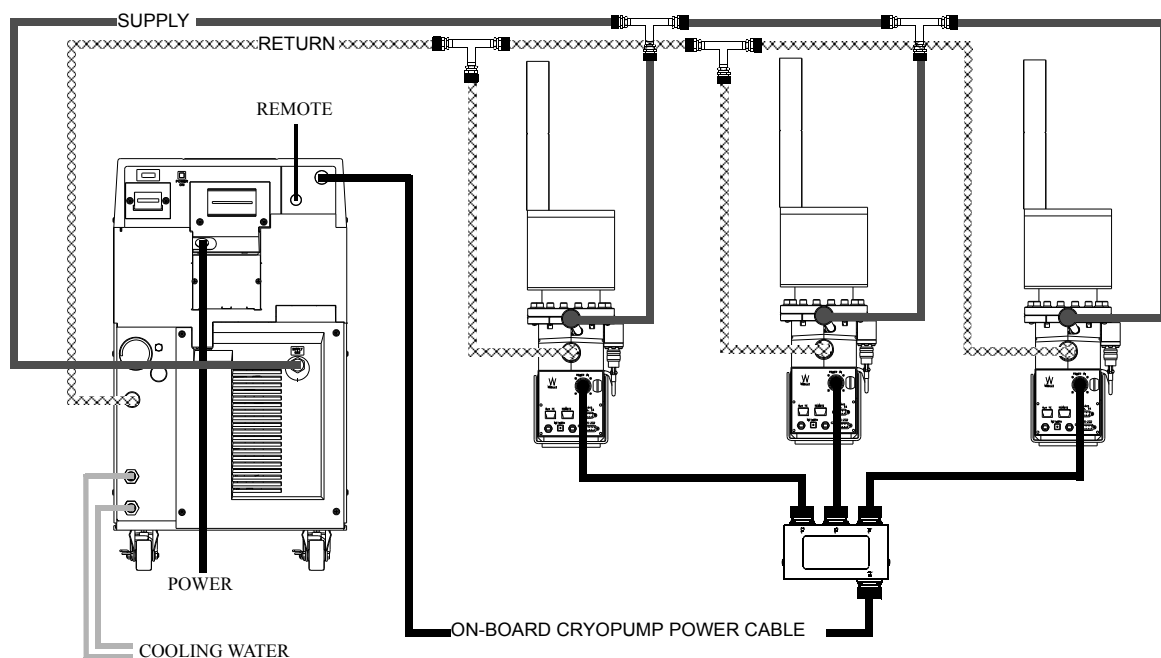

Figure 1-7: 9700A Compressor Connected to Multiple On-Board Waterpumps

Multiple Cryo-Torr Cryopump Connections

The Cryo-Torr Interface permits the connection of multiple Cryo-Torr Cryopumps to one 9700A Compressor as shown in [Figure 1-8](#). The actual number of Cryo-Torr Pumps that can be connected to the 9700A Compressor depends upon the process application and the type of Cryo-Torr pumps required.

NOTE: Refer to Appendix A to consult with your local Brooks Automation Customer Support Center for information on specific compressor/cryopump applications.

Refer to [Chapter 4: Installation](#) for more information on connecting single or multiple Cryo-Torr Cryopumps to the 9700A Compressor.

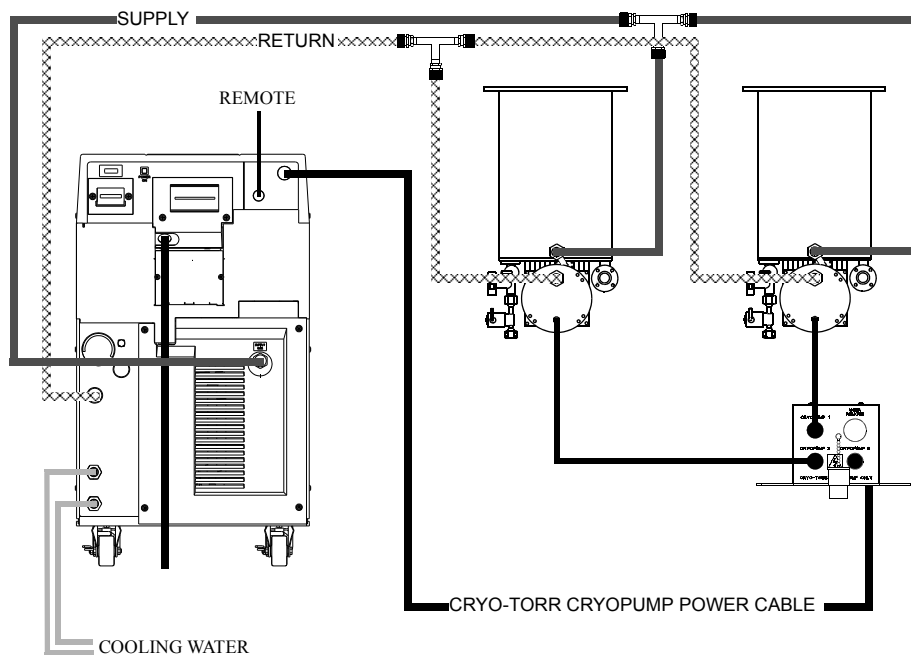

Figure 1-8: 9700A Compressor Connected to Multiple Cryo-Torr Cryopumps

Facilities Specifications (High Voltage)

Following are facilities specifications for Water Cooled HV Compressor Input Power ([Table 1-9](#)) and the HV Compressor Cooling Water ([Table 1-10](#)), respectively.

Table 1-9: Water Cooled HV Compressor Input Power Specifications

Compressor Module	Voltage (VAC)	Frequency (Hz)	Phase	Customer Circuit Breaker (amps)
9700A	380/480	50/60	3	15

Table 1-10: HV Compressor Cooling Water Specifications

Compressor Model	Temperature Range	Flow Rate GPM/ LPM @ 70 F	Pressure Drop PSID
9700A	50°/90° F 10°/32.2° C (Inlet)	3.0 GPM 11.4 LPM	See Figure 1-3 .

Facilities Specifications (Low Voltage)

Following are facilities specifications for Water Cooled LV Compressor Input Power ([Table 1-11](#)) and the LV Compressor Cooling Water ([Table 1-12](#)), respectively.

Table 1-11: Water Cooled LV Compressor Input Power Specifications

Compressor Module	Voltage (VAC)	Frequency (Hz)	Phase	Customer Circuit Breaker (amps)
9700A	200/230	50/60	3	30

Table 1-12: LV Compressor Cooling Water Specifications

Compressor Model	Temperature Max/Min F/C	Flow Rate GPM/ LPM @ 70 F	Pressure Drop PSID
9700A	50°/90° F 10°/32.2°C (Inlet)	3.0 GPM 11.4 LPM	See Figure 1-3 .

2

Safety

Introduction

This chapter describes safety hazard alerts used throughout this manual for the Brooks Automation 9700A Compressor.

All personnel involved in the installation, operation, or maintenance of the 9700A Compressor must follow the safety requirements presented in this manual, along with all safety requirements for the facility where the compressor is installed, and all applicable national and international safety requirements.



Refer to the *Customer Support in Chapter 7: Appendices*, or call your local Customer Support Center, for further assistance.

Hazard Alerts

The **9700A Compressor Installation, Operation, and Maintenance Instructions** use industry standard hazard alerts to make you aware of hazardous conditions. Hazard alerts are composed of three elements:

- Safety Icon
- Signal Word
- Safety Text

Following is an example of a typical hazard alert, with safety icons, signal word, and text.

 	 WARNING
	<p style="text-align: center;">Electric Shock</p> <p>Electric shock can cause severe injury or death.</p> <p>The Access Panel should not be removed from the 9700A Compressor until the power source has been turned OFF.</p> <p>Use the Lockout/Tagout procedure as defined by the facility in which the equipment is installed.</p>

Safety Icons

Safety Icons graphically identify the hazard involved.

The following table provides additional information about safety icons.

Safety Icons

Associated Signal Word	Icon	Description
Caution, Warning or Danger		Identifies the hazard. In this example, electric shock

The safety icons in this manual conform to ISO 3864 and ANSI Z535 standards.

Signal Words

Signal Words inform you of the level of hazard: Caution, Warning, or Danger.

Following are examples of Signal Words used in this manual.

NOTICE

Notice indicates a situation or unsafe practice which, if not avoided, **may result in equipment damage**. The Notice signal word is highlighted in blue.



CAUTION

Caution indicates a potentially hazardous situation or unsafe practice which, if not avoided, **may result in minor or moderate personal injury**. The Caution signal word is preceded by an iconic exclamation point and highlighted in yellow.



WARNING

Warning indicates a potentially hazardous situation which, if not avoided, **could result in serious injury or death**. The Warning signal word is preceded by an iconic exclamation point and highlighted in orange.



DANGER

Danger indicates a potentially hazardous situation which, if not avoided, **will result in serious injury or death**. The Danger signal word is preceded by an iconic exclamation point and highlighted in red.

Text

Hazard alert text follows a standard three-part format:

- identify the hazard,
- state the consequences if the hazard is not avoided,
- state how to avoid the hazard.

The order of hazard alert text is fixed.

The example below illustrates typical hazard alert text in the order stated above.

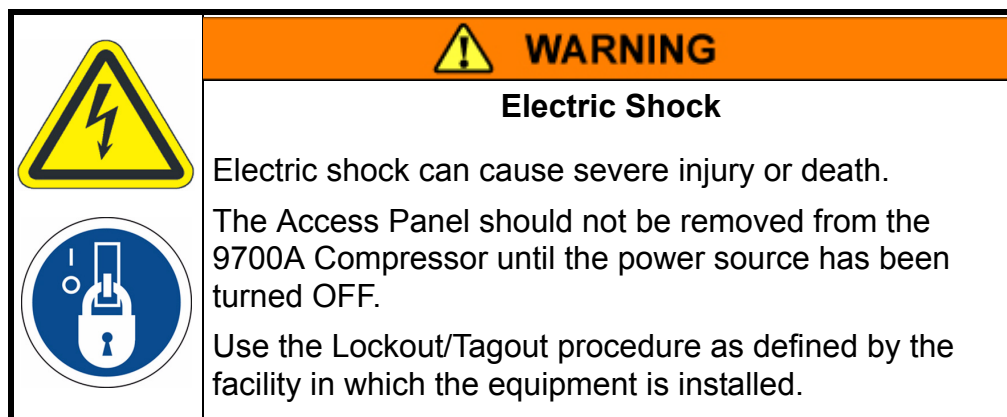



References

For more information about safety standards, refer to the following documents.

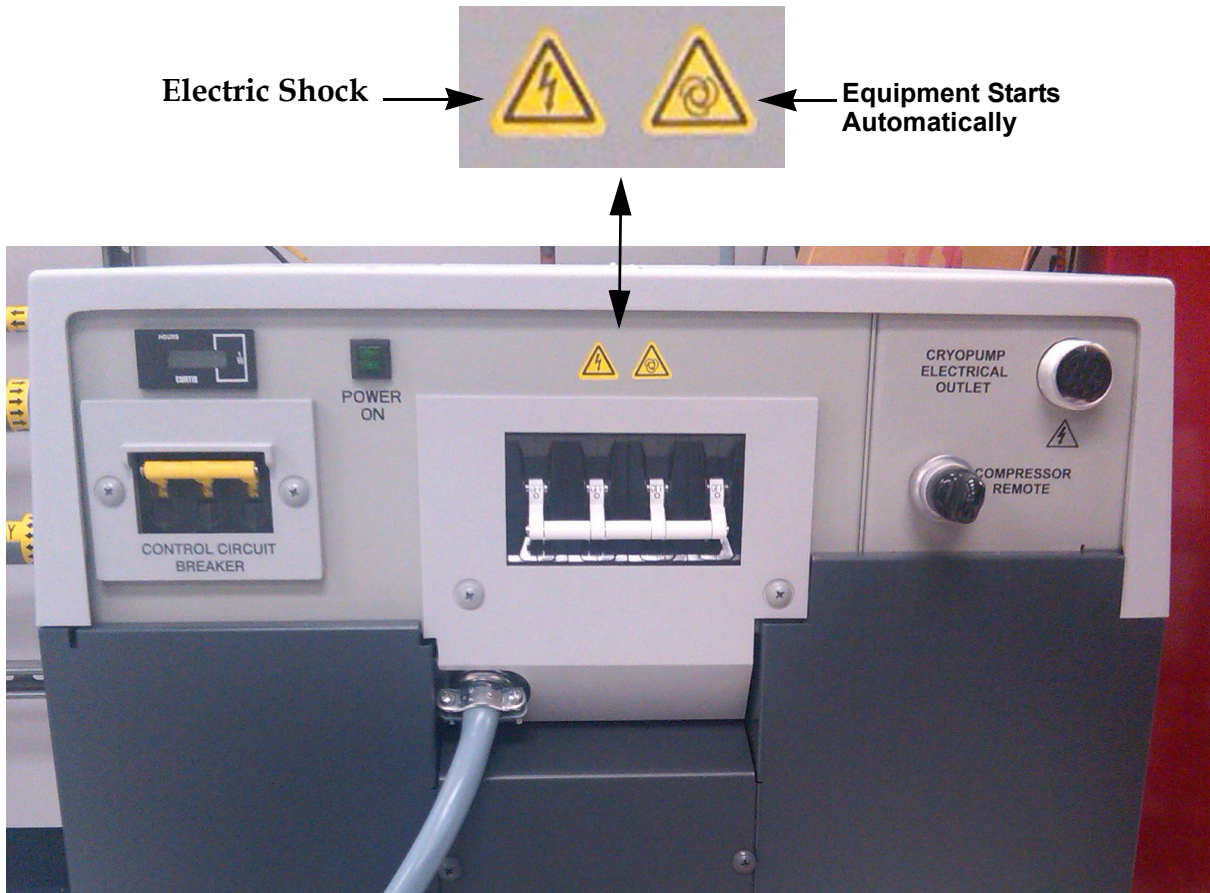

- ISO 3864-2: 2004 Graphical Symbols - Safety Colors and Safety Signs - Part 2: Design principles for product safety labels.
- ANSI Z535.4 Standard for Product Safety Signs and Labels

Safety Labels on the Compressor



	 WARNING
	Electric Shock Electric shock can cause severe injury or death. The Access Panel should not be removed from the 9700A Compressor until the power source has been turned OFF. Use the Lockout/Tagout procedure as defined by the facility in which the equipment is installed.



	 WARNING
	<p style="text-align: center;">Equipment Starts Automatically</p> <p>Automatic startup can cause severe injury. Use the Lockout/Tagout procedure as defined by the facility in which the equipment is installed before attempting to service this equipment.</p>



Location of Safety Labels

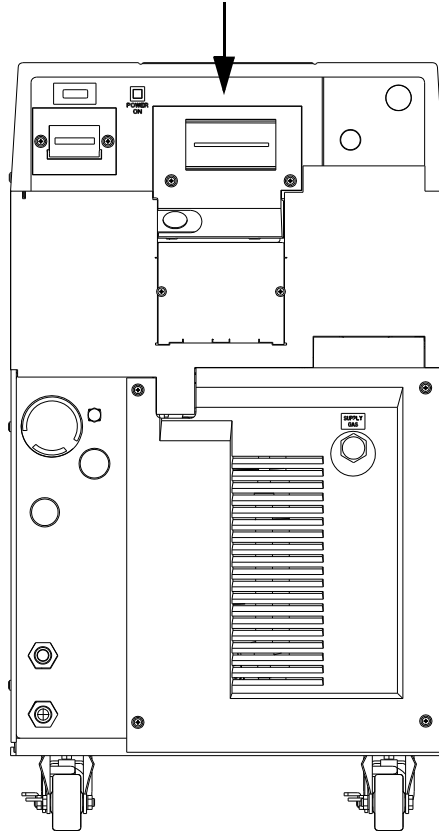

3 Unpacking and Inspection

Introduction

The 9700A Compressor is shipped in a carton that incorporates a ramp system, which makes removing the Compressor from the carton safe and easy.

Shipping Carton Inspection

Inspect the exterior of the shipping carton for visible signs of damage before opening the shipping carton. Report any damage to the shipping company at once.

Removal from Shipping Carton

There are two methods of removing the 9700A Compressor from the shipping carton: using the ramp within the carton, or using a lifting device.

Using the Ramp

1. Cut the two straps on the exterior of the shipping pallet.
2. Lift the cardboard carton straight up and remove it from the pallet.
3. Cut the tape which holds the ramp in the vertical position.
4. Swing the ramp down until the end touches the floor as shown in [Figure 3-1](#).
5. Remove any excess shipping material from around the Compressor.
6. Carefully roll the Compressor down the ramp and onto the floor as shown in [Figure 3-1](#).

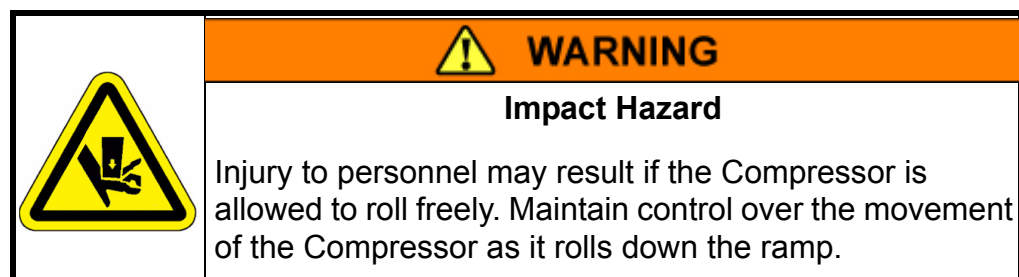

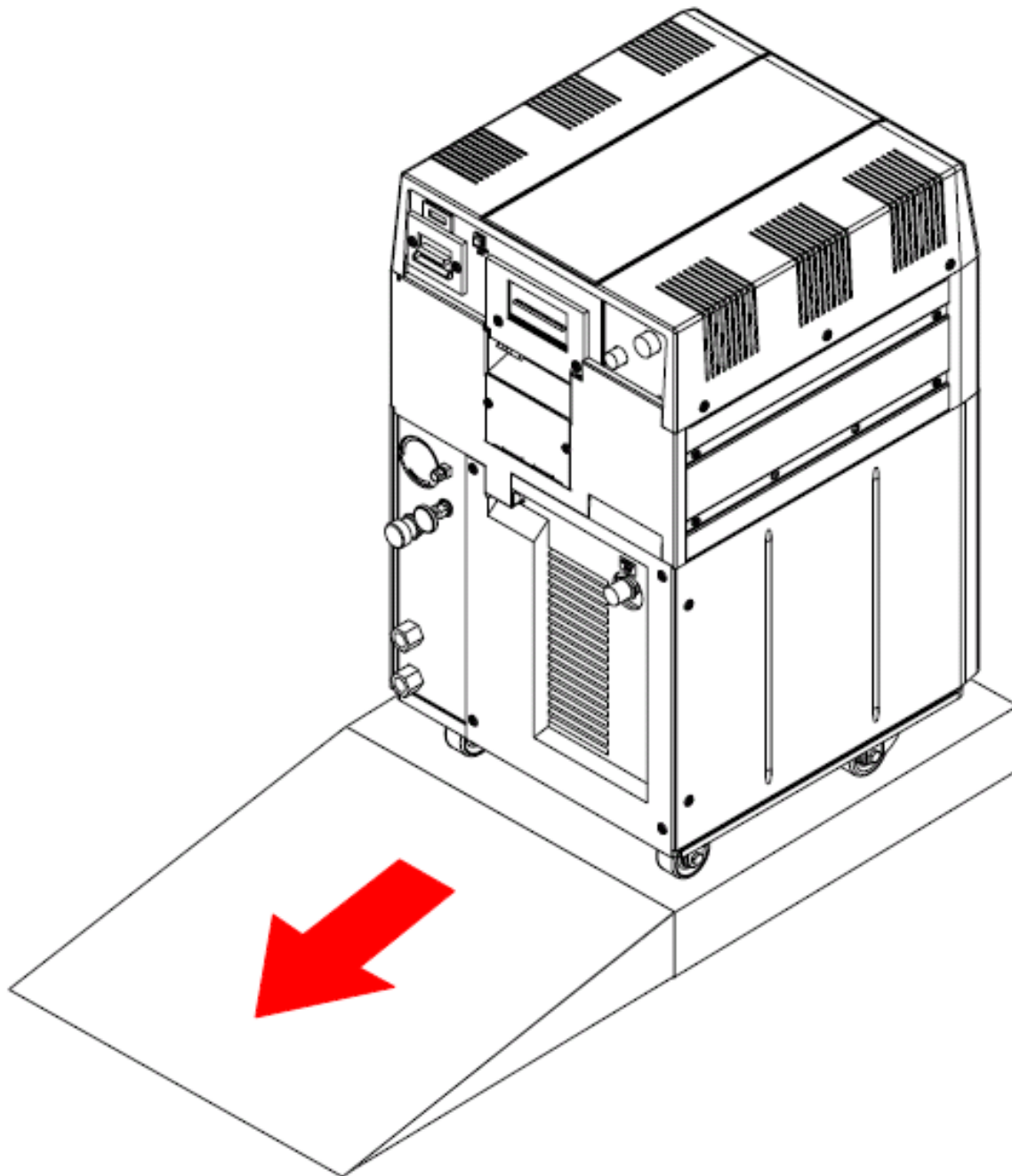

Figure 3-1: Using the Shipping Carton Ramp

Using a Lifting Device

NOTICE

The lifting device must be capable of lifting 159 kg (350 lbs).

1. Cut the two straps on the exterior of the shipping pallet.
2. Lift the cardboard carton straight up and remove it from the pallet.
3. Cut the tape which holds the ramp in the vertical position.
4. Remove the ramp from the shipping carton.
5. Remove any excess shipping material from around the Compressor.

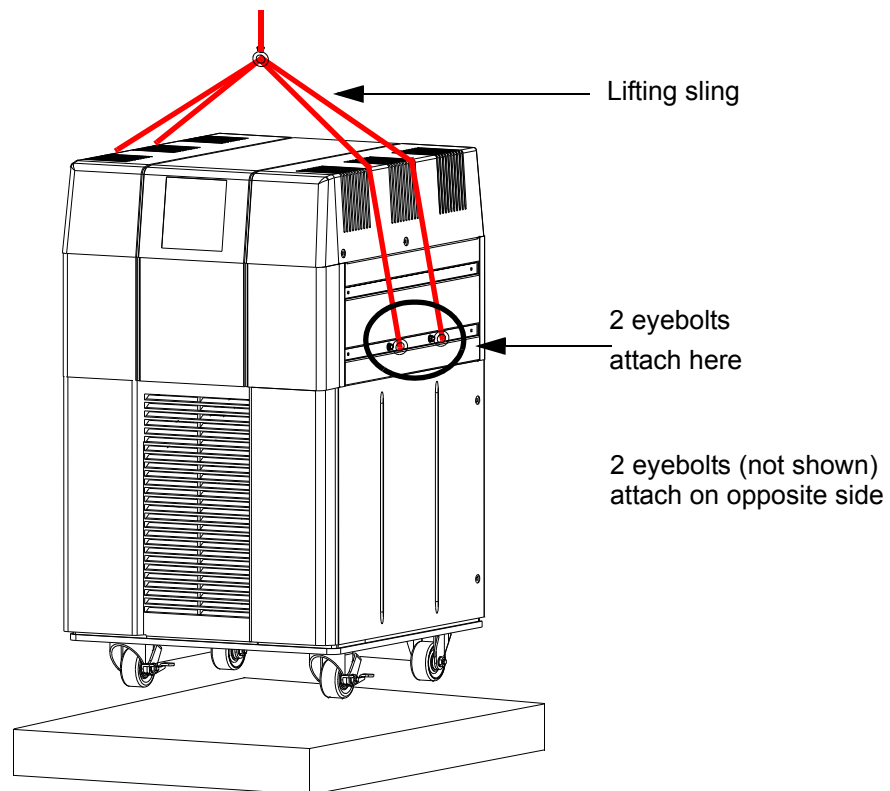

Figure 3-2: Attaching Eye Bolts and Lifting Slings to the 9700A Compressor

6. Install the four customer supplied 3/8 inch x 16 eye bolts into the holes on each side of the 9700A Compressor as shown in [Figure 3-2](#).

NOTICE

The lifting sling minimum length must be 48 inches to prevent damaging the sides of the 9700A Compressor when being lifted from the shipping carton.

7. Attach one lifting sling (minimum 48 inches in length) to each eye bolt as shown in [Figure 3-2](#).
8. Attach the lifting slings to the lifting device and lift the 9700A Compressor off the shipping the shipping carton.
9. Slide the shipping carton out from under the 9700A Compressor.
10. Lower the 9700A Compressor onto its casters and remove the lifting slings and eyebolts.

Compressor Inspection

Inspect the Compressor for visible signs of damage as indicated in the following paragraphs.

Compressor

Inspect the exterior of the Compressor for visible signs of damage, evidence of an oil leak, and check the Helium Pressure Gauge for proper helium pressure. Report any damage to the shipping company at once.

Helium Static Pressure Verification

Refer to [Chapter 5: Operation](#) for more information on the static helium charge pressure of the 9700A Compressor.

Shipping Carton Contents

The shipping carton should contain the following items:

- Compressor
- Two barbed fittings for flexible water lines
- Installation, Operation, and Maintenance manual
- Compressor remote start connector and strain relief

4

Installation

Introduction

This chapter provides the instructions for installing the 9700A Compressor and connecting it to single or multiple On-Board or Cryo-Torr Cryopump configurations. [Figure 4-1](#) highlights the appropriate procedures for 9700A Compressor installation.

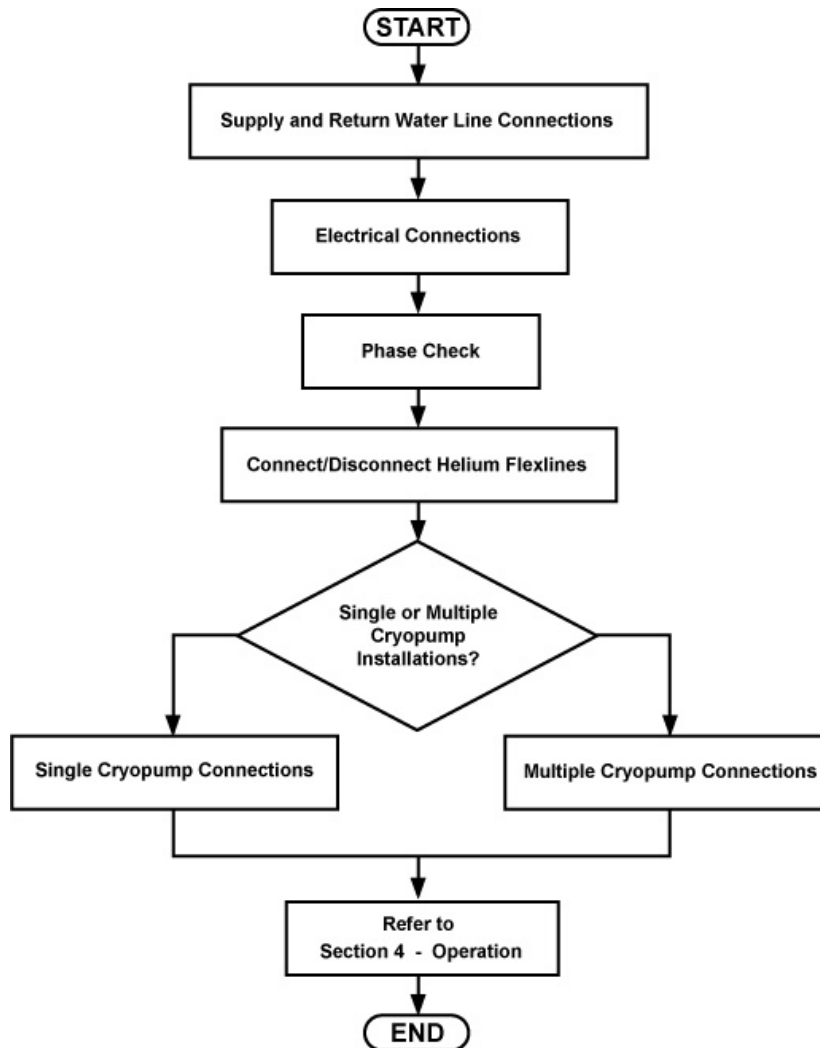

Figure 4-1: 9700A Compressor Installation Flowchart

Supply and Return Water Line Connections

NOTE: *The water used for cooling the 9700A Compressor must meet the specifications outlined in Chapter 1 - 9700A [Cooling Water](#).*

Hard Water Lines

1. Apply a light coating of standard plumbing thread sealant to the hard line pipe threads.
2. Install the Supply hard line into the INPUT connection on the rear panel of the 9700A Compressor. Tighten the fitting by hand.
3. Install the Return hard line into the OUTPUT connection on the rear panel of the 9700A Compressor. Tighten the fitting by hand.

NOTICE

Do not overtighten the ferrules. Damage to the input and output connector threads can occur.

4. Tighten the fittings with a wrench.
5. Allow water to flow and check for leaks at the rear of the 9700A Compressor.

Flexible Water Lines

1. Apply a light coating of standard plumbing thread sealant to the barbed fitting threads.
2. Install the barbed fittings into the INPUT and OUTPUT connections on the rear panel of the 9700A Compressor.



NOTICE



Do not overtighten the barbed fittings. Damage to the INPUT and OUTPUT connector threads may occur.

3. Tighten the barbed fittings.



4. Connect the Supply flexible water line to the INPUT barbed fitting and secure with a hose clamp.
5. Connect the Return flexible water line to the OUTPUT barbed fitting and secure with a hose clamp.
6. Allow water to flow and check for leaks at the rear of the 9700A Compressor.

Electrical Connections

	 CAUTION
	<p style="text-align: center;">High Voltage Electric Shock</p> <p>Electric shock can cause severe injury or death.</p> <p>The following procedures provide information for making all three phase 380/480 50/60 electrical connections to the 9700A Compressor.</p>

	 CAUTION
	<p style="text-align: center;">Low Voltage Electric Shock</p> <p>Electric shock can cause severe injury or death.</p> <p>The following procedures provide information for making all three phase 200/230 50/60 electrical connections to the 9700A Compressor.</p>

Power Cable Preparation

 WARNING	
 	<p style="text-align: center;">Electric Shock</p> <p>Electric shock can cause severe injury or death.</p> <p>The 9700A High Voltage Compressor power cord must be installed by qualified personnel in accordance with the National Electrical Code, ANSI/NFPA 70-1987, as well as all local codes. The cable used for making the 9700A High Voltage Compressor power cable must be a 10 AWG, 3 conductor cable plus ground rated at 600 VAC. The power cord installation shall include the installation of a readily accessible disconnect/device into the fixed wiring supplying power. Follow all local high voltage safety precautions when performing this procedure to reduce the possibility of electrical shock. Ensure all electrical power is OFF before proceeding with this procedure. Perform Lockout/Tagout as defined by the facility in which the equipment is installed.</p> <p style="text-align: center;">NOTE: <i>A disconnect device must be installed as part of the electrical service.</i></p>

1. Cut a 10 AWG (6.00 mm²) 3 conductor cable with ground to an appropriate length.
2. Strip the cable jacket back 4 inches (101.6 mm).
3. Strip the insulation back 3/8 inch (9.3 mm) on each individual conductor.
4. Install a #10 ring tongue terminal on the end of each conductor using the appropriate size double crimping tool.
5. Remove the access panel as shown in [Figure 4-2](#) and described Note below.
6. Remove the circuit breaker terminal cover as shown in [Figure 4-2](#).
7. Install the cable into the 9700A Compressor through the cable strain relief.
8. Remove the 10-32 nut and install the grounding wire on the ground stud. Install the nut and tighten to 18 in.-lbs (0.21m-kg).

NOTE: Use a slotted screwdriver that can hold a screw when performing steps 9 and 10. Remove the screws from the 9700A Compressor circuit breaker terminals X, Y, and Z as shown in [Figure 4-2](#).

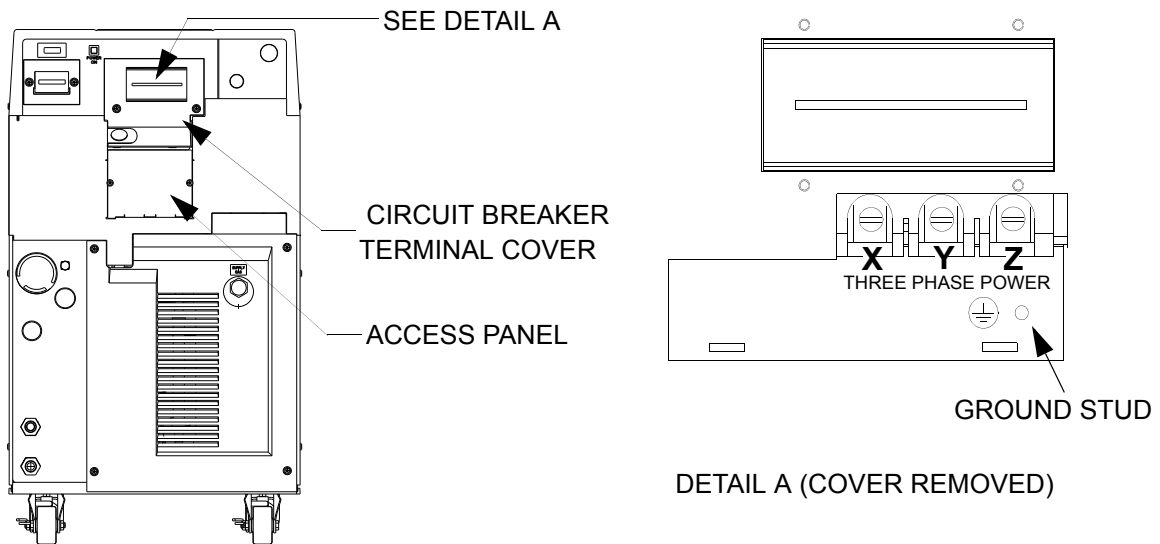

Figure 4-2: 9700A Compressor Circuit Breaker Terminals

NOTE: The phase order in which the conductor terminal lugs are connected to circuit breaker terminals X, Y, and Z will be determined during the Phase Check Procedure.



NOTE: For Japanese (or similar) installations where one of the three phase legs is at or near ground potential, connect that leg to terminal Y on the 9700A Compressor as shown in [Figure 4-2](#).

9. Install the conductor terminal lugs to the circuit breaker terminals X, Y, and Z as shown in [Figure 4-2](#).
10. Torque the screws to 12 in.-lbs (0.14m-kg).
11. Allow enough cable to stay in the electrical enclosure to prevent strain on the electrical connections and tighten the screws on the cable strain relief.
12. Install the power source end of the power cable according to the local electrical codes.

NOTE: A disconnect device must be provided. The System CB is not intended as a disconnect device.

13. Install the circuit breaker terminal cover.
14. Proceed with Phase Check.

Phase Check

 	 WARNING
	Electric Shock Electric shock can cause severe injury or death. Follow all high voltage safety precautions when performing this procedure to prevent the possibility of electrical shock. Use the Lockout/Tagout procedure as defined by the facility in which the equipment is installed.

1. Ensure power is applied to 9700A Compressor circuit as described in [Table 1-2](#).

NOTE: *The circuit breaker will trip immediately during step 2 if the power phase connections are not correct.*

2. Turn the 9700A Compressor circuit breaker to the ON position. If the circuit breaker trips, refer to step 3. If the circuit breaker does not trip, refer to step 4.
3. If the circuit breaker trips, perform the following steps:
 - a. Turn the 9700A Compressor circuit breaker to the OFF position.
 - b. Shut power OFF at the power source.
 - c. Remove the circuit breaker terminal cover.
 - d. Reverse the wiring order of 9700A Compressor circuit breaker terminals X and Y.
 - e. Torque the circuit breaker terminal screws to 12 in.-lbs.
 - f. Install the circuit breaker terminal cover.
 - g. Turn power ON at the power source.
 - h. Repeat steps 1- 2 of this procedure.

4. If the circuit breaker does NOT trip, perform the following steps:
 - a. Shut power OFF at the power source.
 - b. Install the circuit breaker terminal cover.
 - c. Turn power ON at the power source.

NOTE: *Do not turn System CB ON until told to do so.*

Connecting/Disconnecting Helium Flex Lines

NOTICE

Ensure the helium flex lines are connected and disconnected from the 9700A Compressor using the following procedure and as shown in Figure 4-3. Failure to follow this procedure could damage connector O-ring seals or cause a helium circuit leak.

Connecting

1. Remove all dust plugs and caps from the Gas Supply and Return lines, and the 9700A Compressor and cryopump Supply and Return connectors. Check for the presence of a flat gasket in the male connector, and no gasket in the female connector.
2. Connect the Gas Return line to the GAS RETURN connector on the rear of the 9700A Compressor and then to the GAS RETURN connector on the cryopump. Using two wrenches as shown in [Figure 4-3](#), tighten the connector.
3. Connect the Gas Supply line to the GAS SUPPLY connector on the rear of the 9700A Compressor and then to the GAS SUPPLY connector on the cryopump. Using two wrenches as shown in [Figure 4-3](#), tighten the connector.
4. Attach the Supply and Return line identification labels to each end of the appropriate lines.

Disconnecting

1. Using two wrenches as shown in [Figure 4-3](#), disconnect the two self sealing coupling connectors quickly to minimize helium leakage.

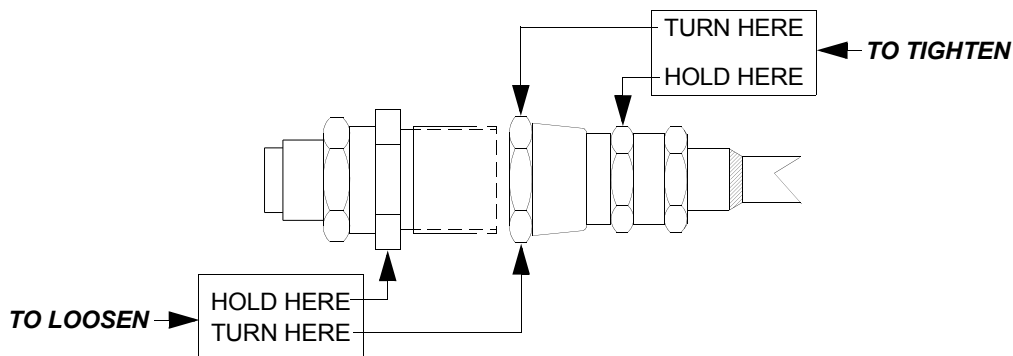

NOTE: TURN USING 1 3/16 INCH WRENCH.

NOTE: HOLD USING 1 1/8 INCH WRENCH.

Figure 4-3: Connecting/Disconnecting Helium Flex Line Self Sealing Couplings

Single On-Board Pump Connections

NOTICE



Ensure the 9700A Compressor power is OFF before making any connections to the rear panel.
Perform Lockout/Tagout as determined by the facility in which the equipment is installed.

1. Connect the Helium Supply and Return lines between the 9700A Compressor and the On-Board Pump as described in [Connecting/Disconnecting Helium Flex Lines](#) in this chapter.
2. Connect one end of the On-Board power cable to one of the PUMP POWER CONNECTORS on the rear panel of the 9700A Compressor as shown in [Figure 4-4](#).
3. Connect the opposite end of the On-Board power cable to the On-Board Pump power cable connector as shown in [Figure 4-4](#)

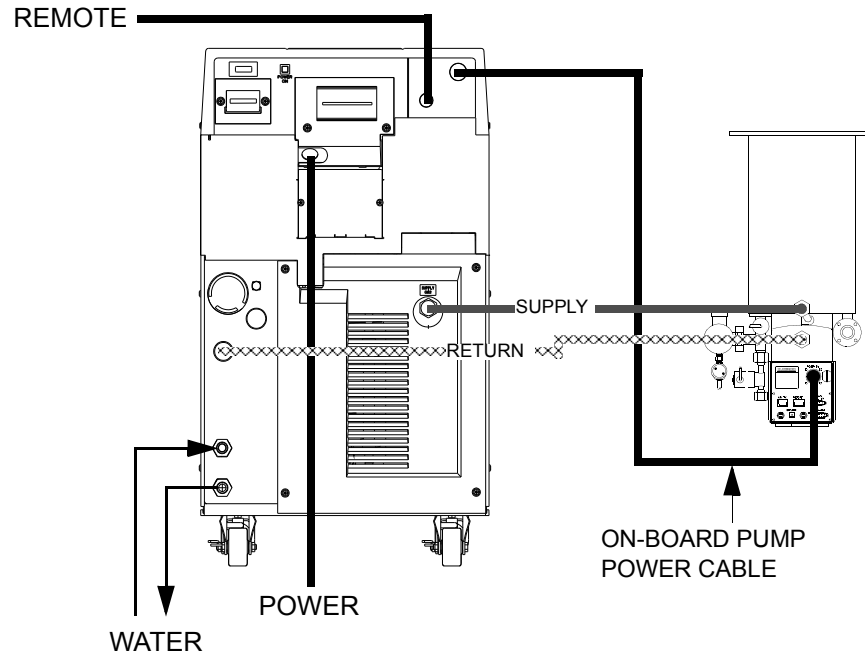



Figure 4-4: Single On-Board Pump Connections

4. If applicable, connect the compressor remote cable to the REMOTE connector as shown in [Figure 4-4](#).
5. Refer to [Chapter 5: Operation](#) to verify the system helium static charge pressure and to start the 9700A Compressor.

Single Cryo-Torr Cryopump Connections

NOTICE	
	Ensure the 9700A Compressor power is OFF before making any connections to the rear panel. Perform Lockout/Tagout as determined by the facility in which the equipment is installed.

1. Connect the Helium Supply and Return lines between the 9700A Compressor and the Cryo-Torr Cryopump as described in [Connecting/Disconnecting Helium Flex Lines](#) in this chapter.

2. Connect one end of the Cryo-Torr power cable to one of the PUMP POWER CONNECTORS on the rear panel of the 9700A Compressor as shown in [Figure 4-5](#).
3. Connect the opposite end of the Cryo-Torr power cable to the Cryo-Torr Cryopump power cable connector.

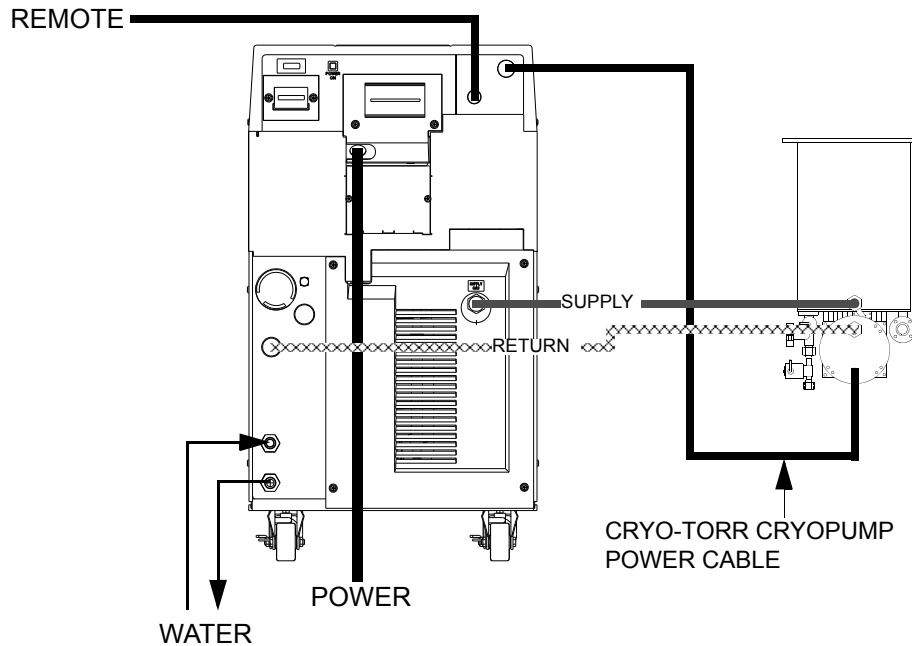

Figure 4-5: Single Cryo-Torr Cryopump Installation

4. If applicable, connect the compressor remote cable to the REMOTE connector.
5. Refer to [Chapter 5: Operation](#) to verify the system helium static charge pressure and to start the 9700A Compressor.

Multiple On-Board Pump Connections

NOTICE



Ensure the 9700A Compressor power is OFF before making any connections to the rear panel.

Perform Lockout/Tagout as determined by the facility in which the equipment is installed.

Helium Line Connections

NOTICE

9700A Compressors cannot be connected to a helium manifold to which models other than 9700A Compressors are connected due to differences in helium running pressure.

NOTICE

Several 9700A Compressors on a single manifold feeding a common supply header and a common return header require special precautions. Contact BROOKS-CRYOGENICS for a review of the intended installation and for specific technical instructions.

1. Connect the Supply and Return lines to the 9700A Compressor as described in [Connecting/Disconnecting Helium Flex Lines](#) in this chapter.
2. Connect the Gas Return Line to the customer supplied helium manifold and then to the GAS RETURN connector on the On-Board Cryopump.
3. Connect the Gas Supply Line to the customer supplied helium manifold and then to the GAS SUPPLY connector on the On-Board Cryopump.

Power Cable Connections

1. Connect the On-Board power cable between the CRYOPUMP POWER CONNECTOR on the rear panel of the 9700A Compressor and the On-Board Splitter Box power connector as shown in [Figure 4-6](#).

2. Connect the On-Board Pump power cables to the CRYOPUMP 1, 2, or 3 connectors on the On-Board Splitter Box and the respective On-Board Pumps.

NOTE: *Your installation (number of pumps per 9700A Compressor) will vary based upon the On-Board Cryopump models used. Refer to Appendix A - Customer Support Information to consult your local BROOKS-CRYOGENICS Customer Support Center for information on specific compressor/pump applications.*

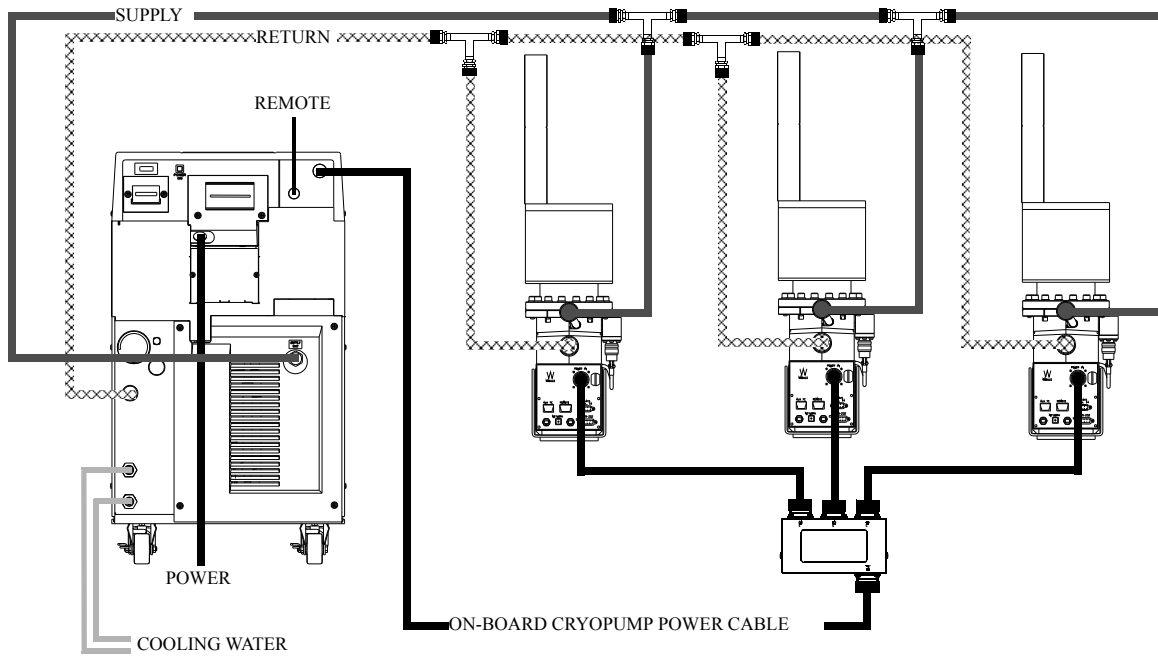

Figure 4-6: Connecting Multiple On-Board Pumps to the 9700A Compressor

Multiple Cryo-Torr Cryopump Connections

NOTICE

Ensure the 9700A Compressor power is OFF before making any connections to the rear panel.



Perform Lockout/Tagout as determined by the facility in which the equipment is installed.

Helium Line Connections

NOTICE

Several 9700A Compressors on a single manifold feeding a common supply header and a common return header require special precautions. Contact BROOKS-CRYOGENICS for a review of the intended installation and for specific technical instructions.

1. Connect the Supply and Return lines to the 9700A Compressor as described in [Connecting/Disconnecting Helium Flex Lines](#) in this chapter.
2. Connect the Gas Return Line to the customer supplied helium manifold and then to the Gas Return connector on the Cryo-Torr Cryopump.
3. Connect the Gas Supply Line to the customer supplied helium manifold and then to the Gas Supply connector on the Cryo-Torr Cryopump.

Power Cable Connections

1. Connect the Cryo-Torr power cable between the CRYOPUMP POWER CONNECTOR on the rear panel of the 9700A Compressor and the CRYOPUMP ELECTRICAL INPUT on the Cryo-Torr Interface as shown in [Figure 4-7](#).
2. Connect the Cryo-Torr Power Cables between the CRYOPUMP 1, 2, or 3 connectors on the Cryo-Torr Interface and the respective Cryo-Torr Cryopumps.
3. Connect the User Remote cable to the Cryo-Torr Interface.
4. Connect the Remote cable between the Cryo-Torr Interface and the 9700A Compressor.

NOTE: Your installation may vary based upon the Cryo-Torr Cryopump models used. Refer to [Chapter 7: Appendices](#), Customer Support Information, for information on specific compressor/cryopump applications.

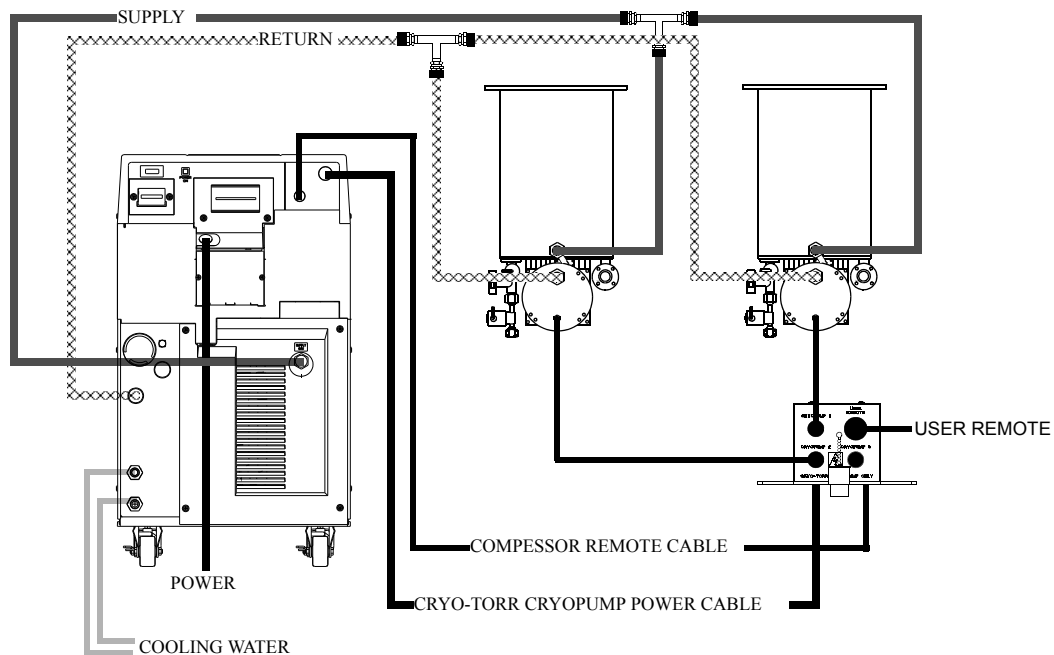

Figure 4-7: Multiple Cryo-Torr Cryopump Installation

5

Operation

Adjusting System Helium Pressure

The BROOKS-CRYOGENICS high vacuum pump system consists of a compressor, flex lines, and cryopumps. Each component is charged with helium before shipment. After all cryopumps, helium lines, and manifolds are attached to the compressor, the system *static helium charge pressure* must be verified *before* system operation. Once the static helium system pressure has been verified, the system is ready for operation. After cooldown, the *normal system operating pressure* is recorded.

NOTE: *The 9700A Compressor is designed for continuous operation and should remain ON even when the cryopumps are in a regeneration cycle.*

Static Helium System Pressure Verification

The proper system static helium charge pressure is necessary so that the cryopumps operate at maximum performance as well as to assure that the compressor will operate below the maximum design motor winding temperature which will maximize the life of the compressor motor.

1. Ensure the Compressor and Cryopump(s) are OFF.
2. Ensure all system components are connected together as described in [Chapter 4: Installation](#).
3. Allow all system components to acclimate to a temperature between 60° F and 80° F (15.5° C - 26.6° C).
4. Read the compressor helium pressure gauge located on the compressor rear panel as shown in [Figure 1-5](#). Compare the gauge reading to the appropriate 50/60 Hz line frequency value (depending upon your system installation) indicated in [Table 5-1](#).
5. If the static helium charge pressure is not within the ranges as indicated in [Table 5-1](#), then adjust the charge pressure as described in [Chapter 6: Maintenance](#).

Table 5-1: 9700A Compressor Helium Static Charge

Line Frequency	Helium Static Charge Pressure
60 Hz	220 - 230 psig (15.2 - 15.9 bars)
50 Hz	255 - 265 psig (17.6 -18.3 bars)

NOTE: *The use of a higher helium charge pressure for 50 Hz operation is necessary to compensate for the slower speed at which the compressor operates at 50 Hz. The static charge level for 60 Hz remains at 220 - 230 PSIG.*

NOTICE

Exceeding the recommended system static helium charge pressure will result in the compressor and cryopump safety relief valves opening and releasing excess helium gas.

Compressor Startup and Operation

The system may be operated once the helium charge pressure is correct. Perform the following steps to start the compressor:

1. Set the System Circuit Breaker to the ON (UP) position.
2. Set the Control Circuit Breaker to the ON (UP) position.
3. Close all Cryopump gate valves.
4. Refer to the appropriate **On-Board Module Programming and Operation** manual or **Cryo-Torr Cryopump Installation and Service** manual (that came with your pump) and perform the cryopump start-up procedure.
5. Once the second stage temperature for all cryopumps is below 17K, record the compressor pressure gauge reading as the *normal system operating pressure*.

NOTE: *During compressor operation, the compressor gauge reads the pressure of the gas entering the compressor prior to it being compressed.*

6. Affix a copy of the data next to the compressor gauge on each compressor. This data is to be verified for each tool installation and whenever a configuration change is made affecting the amount of system helium gas and line volume.

The compressor pressure reading will decrease from the normal system operating pressure during cryopump regeneration or if fewer cryopumps are being operated. These are normal variations in the compressor pressure reading and should not be cause for concern.

If you have concerns about system performance changing, then check the *normal system operating pressure* which was determined in Compressor Startup and Operation in this chapter. If the normal system operating pressure is not correct, check the system for leaks.

Once the leaks have been repaired, helium must be added to return the system to *normal operating system pressure* as described in Suggested Maintenance Equipment of Helium Circuit Components

On occasion, it may be necessary to replace components such as cryopumps, helium gas lines or compressors, or change the configuration of the system. Whenever any of these conditions occur, **Static Helium System Pressure Verification** should be performed to ensure that static helium pressure has not changed.

NOTICE

Several compressors on a single manifold feeding a common supply header and a common return header require special precautions. Contact Brooks Automation for a review of the intended installation and for specific technical instructions.

NOTICE

9700A Compressors cannot be connected to a helium manifold to which models other than 9700A Compressors are connected due to differences in helium running pressure.

This Page Intentionally Left Blank

6

Maintenance

Scheduled Maintenance

It is recommended to have available the equipment and supplies listed in [Table 6-1](#).



NOTE: Refer to [Chapter 7: Appendices](#), Customer Support Information, to obtain the BROOKS-CRYOGENICS parts listed in this table.

Table 6-1: Suggested Maintenance Equipment and Supplies

Equipment and Supplies	BROOKS-CRYOGENICS P/N
Helium, 99.999% pure	-
Pressure regulator (0-3000/0-400 psi) Assy.	8031403
Helium charging line terminating in a 1/4-inch female flare fitting	7021002P001

Adsorber Replacement

Use the following procedure to change the adsorber every three years.

 	 WARNING
	Electric Shock Electric shock can cause severe injury or death. Use Lockout/Tagout devices according to the procedure defined by the facility where the equipment is installed.

1. Set the System Circuit Breaker on the rear of the 9700A Compressor to OFF.
2. Remove the four screws that secure the rear panel to the Compressor and remove the rear panel.

NOTICE
Use two wrenches in Step 3 to prevent loosening the body of the coupling.

3. Using a 1-3/16 inch wrench and a 1-1/8 inch wrench positioned as shown in [Figure 6-1](#), disconnect the two self sealing coupling connectors quickly to minimize helium leakage.

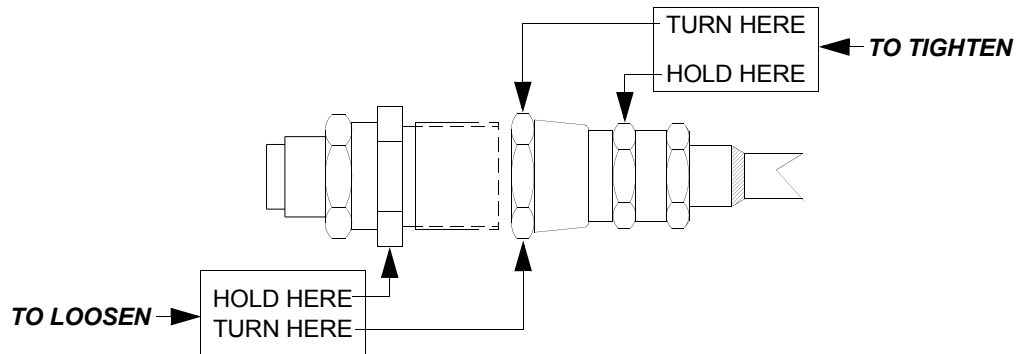

NOTE: TURN USING 1 3/16 INCH WRENCH.

NOTE: HOLD USING 1 1/8 INCH WRENCH.

Figure 6-1: Disconnecting Self Sealing Couplings

4. Using a 7/16 inch (11mm) wrench, remove the adsorber mounting bolt as shown in [Figure 6-2](#).
5. Move the adsorber from under the mounting tabs in the base as shown in [Figure 6-2](#) and remove the adsorber from the Compressor.
6. Install the replacement adsorber under the mounting tabs and secure it into place with the bolt removed in Step 4.
7. Using two wrenches positioned as shown in [Figure 6-1](#), connect the two self sealing couplings quickly to minimize helium leakage.
8. Install the Compressor rear panel.
9. Ensure that the pressure gauge reads the proper value as shown in [Table 5-1](#). If additional gas pressure is required, refer to [Adding Helium](#) in this chapter. If gas pressure needs to be reduced, refer to [Reducing Helium Pressure](#) in this chapter.
10. Record the adsorber replacement date on the label as shown in [Figure 6-2](#), and also note that the next adsorber replacement should be performed every three years.

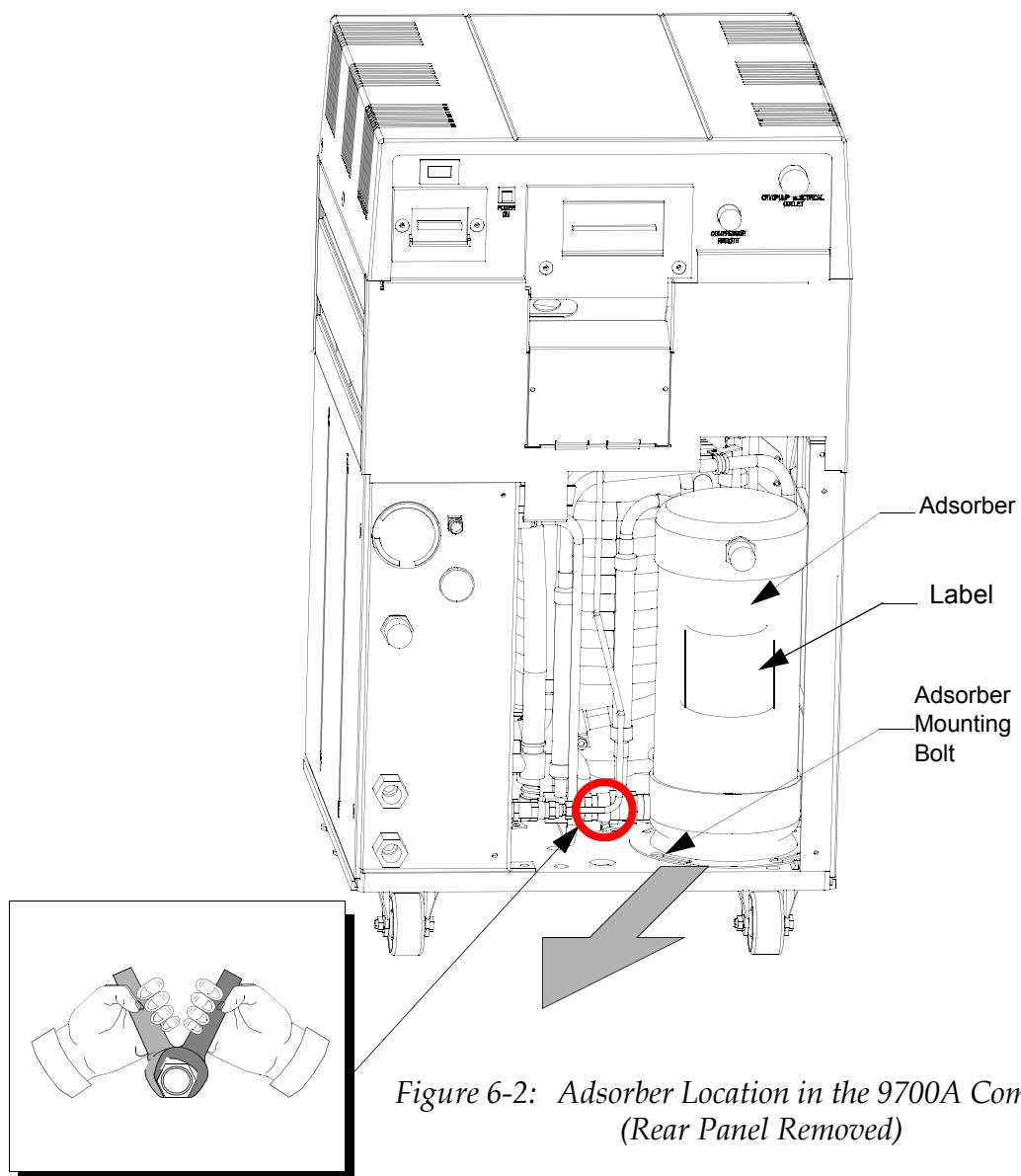

*Figure 6-2: Adsorber Location in the 9700A Compressor
(Rear Panel Removed)*

Adjusting System Helium Pressure

NOTE: *These procedures can be performed on a compressor that is turned ON or OFF. However, the helium pressure gauge should be set to the static helium charge pressure value if the compressor is turned OFF or set to the normal system operating pressure if the compressor is turned ON. Refer to [Chapter 5: Operation](#) for more information.*

Reducing Helium Pressure

NOTE: *You must obtain the normal system operating pressure from the Compressor Operation procedure in [Chapter 5: Operation](#) in order to perform this procedure. If the normal system operating pressure is unknown, then shut the compressor OFF and perform the [Static Helium System Pressure Verification](#) procedure in [Chapter 5: Operation](#) instead.*

1. Remove the flare cap from the gas charge fitting as shown in [Figure 6-3](#).

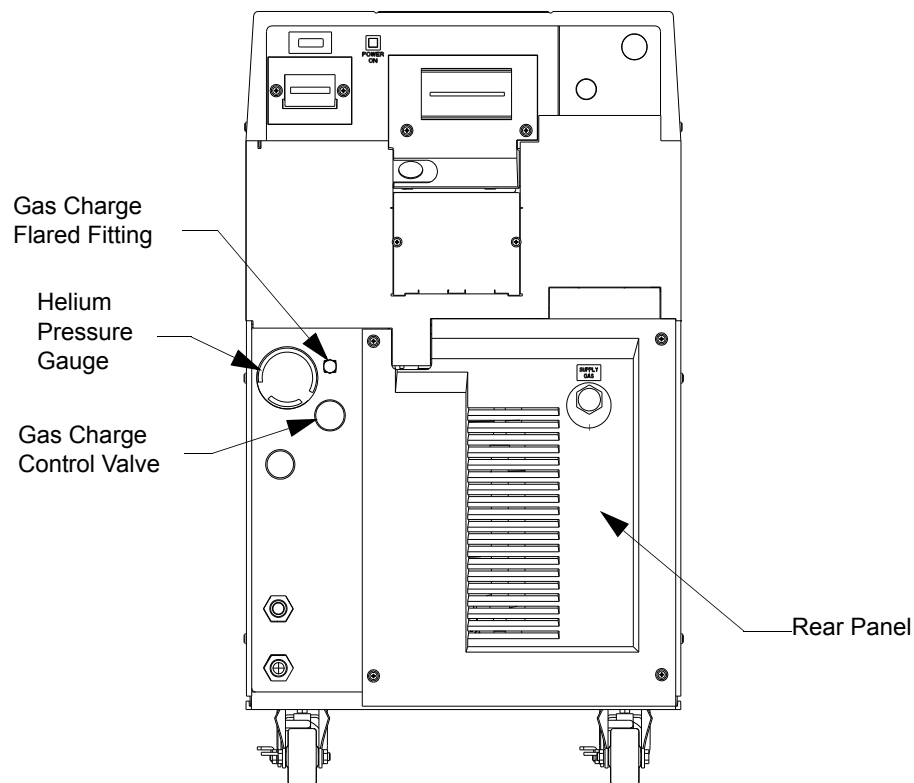

Figure 6-3: Helium Pressure Control Components

2. Open the gas charge control valve *very slowly* to allow a slight amount of helium to escape. Leave the valve open until the helium pressure gauge indicates one of the following:
 - The appropriate value is in [Table 5-1](#) if the compressor is OFF and acclimated to a temperature between 60° F and 80° F (15.5° C - 26.6° C).
 - The value previously recorded in the [Compressor Startup and Operation](#) procedure in [Chapter 5: Operation](#) if the compressor is ON.
3. Close the gas charge control valve and install the flare cap.

Increasing Helium Pressure

Use the following procedure to increase the helium pressure if the indicated pressure is below the appropriate value as shown in [Table 5-1](#).

NOTICE

If helium is being added more than once every several months, check for leaks caused by improperly connected self-sealing connections or any mechanical joint within the Compressor.

Adding Helium

NOTE: *You must obtain the normal system operating pressure from the [Compressor Startup and Operation](#) procedure in [Chapter 5: Operation](#) to perform this procedure. If the normal system operating pressure is unknown, then shut the compressor OFF and perform instead the [Static Helium System Pressure Verification](#) procedure in [Chapter 5: Operation](#).*

This procedure ensures that both the regulator and the charging line will be purged of air and that the air trapped in the regulator will not diffuse back into the helium bottle. For best results, BROOKS-CRYOGENICS suggests a dedicated helium bottle, regulator, and line, which are never separated, for adding helium.

NOTE: *You are required to supply for this operation the helium charging line terminating in a 1/4-inch female flare fitting and a two-stage pressure regulator rated at 0-3000/0-400 psig.*

NOTICE

Use only 99.999% pure helium gas. Helium circuit contamination may result if a lower quality of helium is used.

1. Attach a regulator (0-3000/0-400 psig) and charging line to a helium bottle (99.999% pure).

NOTE: *Do not open the bottle at this time.*

2. Purge the regulator and charging lines as follows:
 - a. Open the regulator a small amount by turning the adjusting knob clockwise until it contacts the diaphragm, then turn it approximately 1/8 to 1/4 turn more, so that the regulator is barely open.
 - b. Loosely connect the charge line to the helium pressure regulator.
 - c. Slowly open the bottle valve, and purge the regulator and line for 10 to 15 seconds. Turn the regulator knob counterclockwise until the helium stops flowing.
3. Remove the flare cap of the gas charge flared fitting on the rear of the Compressor.
4. Loosely connect the charging line from the helium pressure regulator to the 1/4-inch male flare fitting installed on the helium charge valve. Purge the charge line again, as in step 2a, for 30 seconds, and tighten the charge line flare fitting onto the gas charge fitting while the helium is flowing.
5. Set the helium pressure regulator to 300 psig (20.7 bars). If the compressor is ON, proceed to step 5a. If the compressor is OFF, proceed to step 5b.
 - a. Obtain the previously recorded *normal system operating pressure* from the **Compressor Startup and Operation** procedure in [Chapter 5: Operation](#). Open the gas charge control valve *very slowly* and allow helium to flow until the compressor gauge reading is the same as the value obtained from [Chapter 5: Operation](#). Quickly close the gas charge control valve.
 - b. Obtain the appropriate (50 or 60 Hz) *static system operating pressure* from [Table 5-1](#). Open the gas charge control valve *very slowly* and allow helium to flow until the compressor gauge reading is the same as the appropriate value in [Chapter 5: Operation](#). Quickly close the gas charge control valve.
6. Ensure that the helium charge valve on the Compressor is tightly closed. Shut off the helium pressure regulator on the helium bottle and remove the charging line from the male flare fitting. Reinstall the flare cap.

This Page Intentionally Left Blank

7

Appendices

Overview

The following appendices are included to provide the user with a single location for specific information related to the Brooks Automation Product.

Contents

Appendix A: Contact Brooks Automation Technical Support Information	7-2
Appendix B: Flow Diagrams	7-3
Appendix C: Troubleshooting Procedures.	7-4

Appendix A: Contact Brooks Automation Technical Support Information

When contacting Brooks Automation for Technical Support, please have the following information available.

1. Record the part number and serial number from the equipment.
2. Provide the installed location of the equipment.
3. Provide name, e-mail address, and telephone number of the person to contact.
4. List any error codes received during the failure.
5. Prepare a detailed description of the events relating to the error.
 - Time that the equipment has been in operation
 - Work that was done on the equipment prior to the error
 - Functions that the equipment was performing when the error occurred
 - Actions taken after the error and the results of those actions
 - Other information that may assist the Specialist
6. Contact Brooks Automation Technical Support at these numbers:

Brooks Location	GUTS[®] Contact Number
North America	1-800-FOR-GUTS (1-800-367-4887) US/ Canada +1-978-262-2900
Europe	+49 1804 CALL GUTS (+49 1804 2255 4887)
Japan	+81-45-477-5980
China	+86-21-5131-7066
Taiwan	+886-3-552-5225
Korea	+82-31-288-2500
Singapore	+65-6464-1481

For additional contact information, please go to the Brooks Automation web site at www.brooks.com or send an E-mail to techsupport@brooks.com.

Appendix B: Flow Diagrams

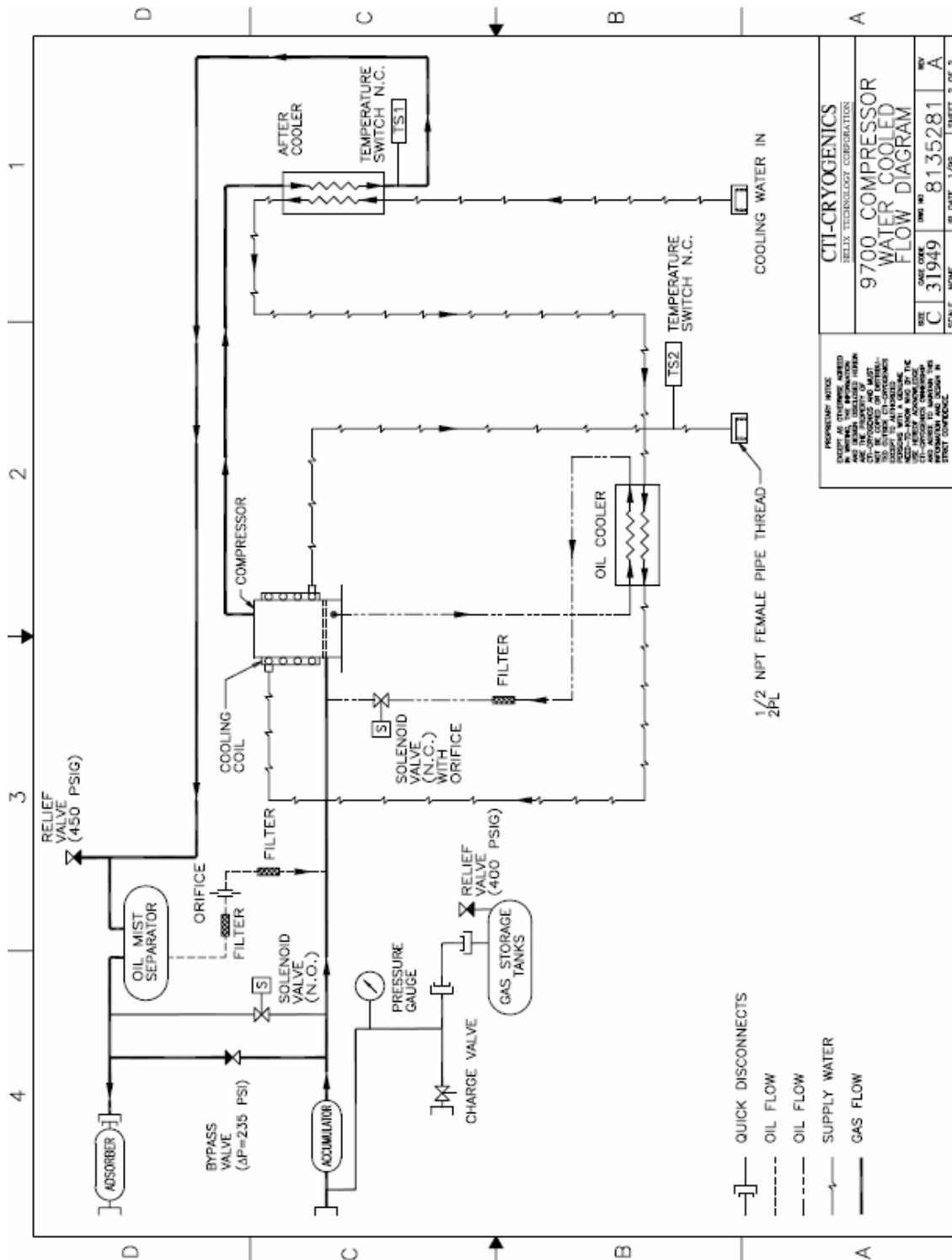

Figure 7-1: 9700A Compressor Water Cooled Flow Diagram



Appendix C: Troubleshooting Procedures

Troubleshooting the Compressor

The compressor troubleshooting procedures are summarized in [Table 7-2](#) below.

Technical Inquiries

Please refer to [Chapter 7: Appendices](#), Customer Support Information, for a complete list of customer support centers.

	 WARNING
	Electric Shock Electric shock can cause severe injury or death. Disconnect the compressor before performing any troubleshooting procedures. Do not change or modify any compressor internal wiring circuits, this may cause failure of the compressor and cold head due to improper phasing.



	 WARNING
	High Heat The compressor pump is hot enough after operating to cause severe burns. Wait for the pump to cool down before working on the inside of the compressor.

Table 7-2: Compressor Troubleshooting Procedures

Problem	Possible Cause	Corrective Action
<p>1) System circuit breaker (CB1) trips immediately to the OFF (0) position when switched to the ON (1) position.</p>	<p>1) Incorrect phasing of input power.</p>	<p>1) Check phasing of input power. Refer to General Operating Specifications.</p>
<p>2) System (CB1) and Control Circuit (CB2) circuit breakers remain in the ON (1) position when switched ON but the compressor will not run.</p>	<p>1) No power coming from source.</p> <p>2) Insufficient power</p> <p>3) Remote control jumper plug not in place. This will apply only if remote circuit <i>is not</i> being used.</p> <p>4) Improperly wired external remote control circuit. NOTE: Only applies if remote control feature is being used.</p>	<p>1) Check source fuses, circuit breakers, and wiring associated with the power source. Repair as needed.</p> <p>2) Verify adequate phase-to-phase input voltage. Refer to Table 1-2.</p> <p>3) Check to insure that remote jumper plug is fully seated. See Figure 1-5 for location. Refer to Compressor Remote Connector in Chapter 1 - for more information.</p> <p>4) Verify correct installation of remote control feature. Refer to Figure 4-4.</p>

Table 7-2: Compressor Troubleshooting Procedures (Continued)

Problem	Possible Cause	Corrective Action
3) System circuit breaker (CB1) will not remain in the ON (1) position when switched ON. The Control Circuit circuit breaker (CB2) trips when excessive current is being drawn by the cold head or 24 volt compressor control circuits.	1) Damaged On-Board power cable, connectors, or drive motor. 2) Damaged component in the compressor power or control circuit.	1) Check for compressor operation with cryopump cable disconnected from compressor. Refer to Appendix A: Contact Brooks Automation Technical Support Information if the compressor operates improperly. 2) Refer to Appendix A: Contact Brooks Automation Technical Support Information .
4) System circuit breaker (CB1) remains in the ON (1) position and the compressor stops after several minutes of operation and remains OFF (0).	1) Thermal protective switches are open. 2) Very cold water has caused a restriction of oil flow through the oil injection orifice during start-up.	1) Check for inadequate water cooling. Refer to Cooling Water IN . 2) Recheck for proper cooling water temperature. Refer to Table 1-3 . Restart compressor repeatedly until continuous operation is achieved.
5) System circuit breaker (CB1) trips after a period of running.	1) Loss or degradation of power from the source. 2) Defective motor windings.	1) Check that line voltage is correct on all phases. 2) Check running current on all phases. 3) Refer to Appendix A: Contact Brooks Automation Technical Support Information .